

HASSELBLAD 203FE

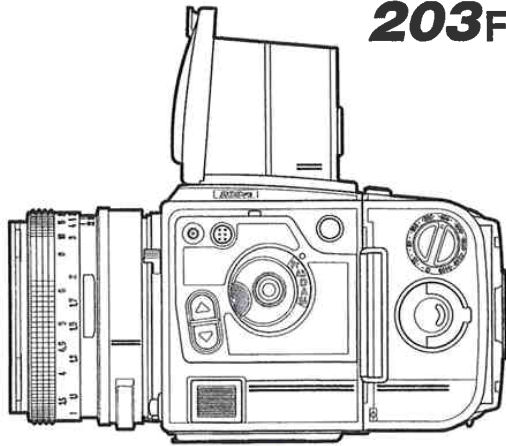

INSTRUCTION MANUAL

Hasselblad 203FE Instruction Manual

Contents	21	Selftimer
3 Hasselblad 203FE Introduction	21	Grip Cushion
4 Parts and Components	22	Front
6 Getting started	22	Shutter Speed Ring
6 Battery	23	Exposure Release Button
6 Cocking the camera	23	Cable Release
6 Front Protective Cover	23	Lens Catch & Shutter Speed Ring Lock
6 Attaching the Lens	24	Rear Side and Focal Plane Shutter
7 Removing the Lens	25	Bottom Side
8 Rear Protective Cover	25	Top Side
8 Attaching the Magazine	26	Viewfinder System
9 Removing the Magazine	26	Changing Focusing Hood/Viewfinder
9 Magazine Status Indicator	26	Changing Magnifier
10 Winding Crank	27	Changing Focusing Screen
10 Removing the Winding Crank	28	Left Hand Side
10 Attaching the Winding Crank	28	Mode Selector
11 Strap and Strap Lugs	28	Automatic Exposure Lock (AE-lock)
11 Attaching the Strap	29	Adjustment Buttons
11 Removing the Strap	29	Flash Connectors
12 Focusing Hood and Magnifier	29	Display Illumination
12 Opening the Focusing Hood	30	Lenses
12 The Built-in Magnifier	30	FE-lenses
12 Closing the Focusing Hood	31	FE-lens Functions
13 Viewfinder Image and Display	31	Aperture
13 Focusing Screen	31	Focusing and Depth-of-field
13 Exposure Meter	32	Depth-of-field Scale
13 Viewfinder Display	32	Depth-of-field Preview
14 Control Panel	33	Infra-red (IR) Photography
16 Left Hand Grip	33	Exposure Value (EV)
16 Activating Camera & Metering System	33	Other Hasselblad Lenses
17 Focusing, Exposure, Viewfinder Display	34	E-Magazine Operation
18 Operating Detail Instructions	34	Loading the Magazine
18 Viewfinder Display & Symbols	36	Magazine Load Status
20 Right Hand Side	36	Removing the Film
20 Double Exposure	36	Film Tab Holder
20 Mirror and Mechanism Pre-release	36	Film Speed Dial

Contents 1

37 Magazine Slide Pocket	76 Hasselblad System Chart
37 Film Plane Index	78 Trouble-shooting
38 203FE Metering System and Operating Modes	81 Technical Specifications
38 The Metering System	83 Camera Body Dimensions
39 Operating Modes	84 Camera Care, Service and Guarantee
39 Pr Programming Mode	85 APPENDIX A
40 How to use the "Pr" Mode	85 Hasselblad 203FE with CF- and C-lenses
44 Ab Automatic Bracketing Mode	85 CF-lenses
45 How to use the "Ab" Mode	85 CF-lens Design and Function
49 D Differential Mode	86 F-setting
49 How to use the "D" Mode	87 How to use the CF-lens
51 A Automatic Mode	88 Flash photography with CF-lens
52 M Manual Mode	89 Lens in F Mode
52 How to use the "M" Mode	89 Dedicated and Non-dedicated Flash Units
54 M(ref) Manual Mode, reference	89 Lens in C Mode
54 How to use the "M(ref)" Mode	89 Dedicated Flash Units
55 M(L,E.) Manual Mode, Long Exposure	91 Non-dedicated Flash Units
57 How to use the "M(L,E.)" Mode	92 C-lenses
58 Warning Functions	92 How to Use the C-lens
58 Permanent Warnings	93 Flash Photography with C-lens
59 Optional Warning	
59 Flash Photography	
59 Dedicated Flash Units	
60 How to use the Dedicated Flash	
60 Flash set at TTL Mode	
64 Flash set at Automatic Mode	
67 Flash set at Manual Mode	
70 Non-Dedicated Flash Units	
71 How to use a Non-dedicated Flash	
71 203FE with other Hasselblad Lenses	
72 F-lenses	
72 How to use the 203FE with an F-lens	
73 Flash Photography with F-lens	
74 Accessories	
74 Accessory Mounts	
74 Major FE Accessories	
	Service and Maintenance
	The Hasselblad products are exceptionally reliable and durable, but continuous and extensive professional use will require maintenance and overhaul at regular intervals at an authorized Hasselblad Service Center. Turn to page 82 and read about maintenance and service!
	Warranty
	Provided you purchased the equipment from an authorized Hasselblad dealer or distributor it is covered by an international warranty for one year from the date of delivery. Read more about the warranty on page 82!

2 Contents

HASSELBLAD 203FE – Speed and precision

Your Hasselblad 203FE is a camera designed for professionals who often work on location under unpredictable light conditions and fast-moving subjects. With the 203FE you have a choice of either aperture priority automatic or truly manual function. In the automatic modes you can manually adjust the computer-controlled exposure within the range +5 to -5 EV. The extremely accurate focal plane shutter provides the widest range of shutter speeds in the medium format field: 34 minutes to ultra fast 1/2000 s with 1/2 stop increments in manual mode or 90 s to 1/2000 s with 1/12 stop increments in automatic mode. It also provides the fastest flash sync speed among medium format focal plane shutters: 1/90 s.

Primarily designed to take advantage of this remarkable shutter are the Hasselblad FE (former TCC) series lenses, ranging from the medium wide-angle 50mm 1/2.8 to the short telephoto 350mm f/4, including the powerful Planar 110mm 1/2. And using the Hasselblad Converter 2XE in one stroke doubles the range of focal lengths!

These outstanding lenses by Carl Zeiss are supported by the brightest possible viewfinder image, provided by the Acute-Matte focusing screen, completed with the illuminated LCD display with all relevant exposure and setup data.

The metering system compiles the information from the lens, the built-in exceptionally sensitive light meter, and the film speed setting on the attached E or TCC magazine to calculate the accurate shutter speed. If any of the parameters, e.g. the pre-set aperture, is changed the shutter speed changes accordingly.

Attaching the Hasselblad Winder motorizes your 203FE for the full use of the automatic bracketing function with a frame rate of 1.3 fps and your own choice of 1/3-, 2/3- or 1-step bracketing interval. Press the exposure button and hold for the number of frames you decide – the camera automatically adjusts the shutter speed according to your choice, 1/90 s.

Above all, according to the Hasselblad philosophy, your 203FE can use the full range of Hasselblad CF lenses with built-in shutters for the added advantage of battery-independent shutter operation and a wide range of shorter flash sync speeds and focal lengths.

This instruction manual describes in detail how to operate your Hasselblad 203FE. Read it carefully to avoid mistakes and to get full access to the Hasselblad potential. Exploiting that potential is limited by your own imagination only!

Introduction 3

203FE, Parts and Components

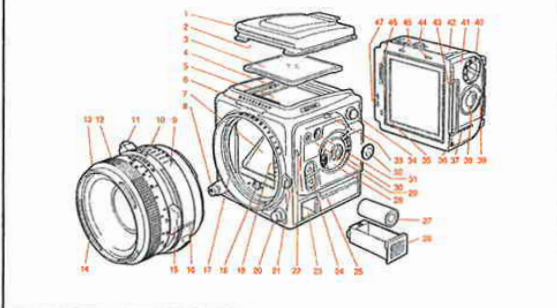

1 Focusing hood cover	17 Lens mount	33 Display illumination button
2 Display recess	18 Drive shaft	34 Strap lug
3 Acute-Matte* focusing screen	19 Data bus connection bracket	35 Indicator trigger slot
4 Focusing screen catch	20 Lens catch / Shutter speed ring lock	36 Film plane indicator
5 Liquid crystal display (LCD)	21 Shutter speed ring	37 System mark
6 Display illumination window	22 Selftimer indicator	38 Film load indicator
7 Viewfinder mirror	23 Battery compartment	39 Film holder key
8 Shutter release button	24 Adjustment button	40 Film speed dial
9 Aperture ring with scale	25 Grip cushion	41 Film holder
10 Depth-of-field scale	26 Battery cassette	42 Film magazine
11 Interlock button (not on FE)	27 Battery	43 Magazine slide
12 Focusing ring	28 Mode selector dial	44 Film magazine catch
13 Lens front bayonet, exterior	29 PC socket	45 Magazine hook slot
14 Lens front bayonet, interior	30 Automatic exposure lock, AE-lock	46 Magazine gear
15 Depth-of-field preview knob	31 Dedicated flash connector	47 System connectors
16 System mark	32 Flash connector socket cover	

*Acute Matte designed by MINOLTA

4 Parts and Components

203FE, Parts and Components

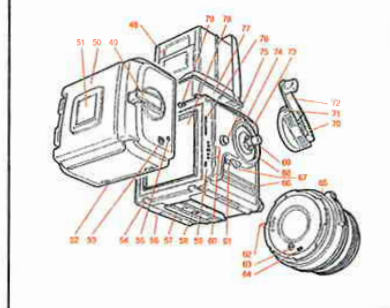

48 Focusing hood	58 Tripod thread 1/4"	68 Winder coupling
49 Film winding crank	59 Magazine indicator trigger	69 Double exposure button
50 Magazine slide pocket	60 Data bus connectors	70 Crank hub
51 Film tab holder	61 Selftimer indication	71 Winding crank catch
52 Magazine support slot	62 Lens data bus connectors	72 Winding crank
53 Frame counter	63 Lens drive shaft	73 Winder bayonet mount
54 Magazine support	64 Lens drive shaft catch	74 Winding crank index
55 Magazine status indicator	65 Lens bayonet plate	75 Strap lug
56 Camera support	66 Grip cushion	76 Magazine driving gear
57 Mirror coupling slide	67 Mirror release / selftimer button	77 Magnifier
		78 Shutter curtain
		79 Magazine hooks

NOTE: In the text the positions of components are described in relation to the camera as you see it when taking a photograph, i.e. the lens is on the front, the viewfinder is on the top, the winding crank is on the right hand side, and the control panel is on the left hand side.

Parts and Components 5

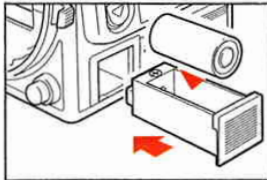

Getting Started

This section describes how you prepare your Hasselblad 203FE for use. You will find comprehensive information how to operate the camera in the section starting on page 18. Follow the instructions step by step to avoid jamming or damaging the camera. Always keep the rear protective cover on to protect the shutter curtain when the magazine is detached!

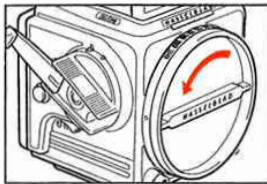

Battery

The battery compartment and cassette is located in the lower forward corner on the left hand side of the camera body. Pull out the cassette and install the battery - 6V type PX28L or equivalent - according to the marking on the cassette. Push the cassette all the way back into the compartment.

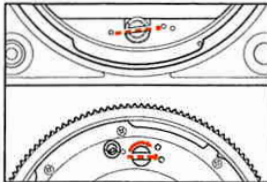

Cocking the Camera

Cock the camera after installing the battery. Fold out the winding crank on the right hand side, press the button in the center of the crank and rotate it clockwise one turn until it locks (Cf. page 20, 'Double exposure').

Front Protective Cover

The front protective cover is attached to the lens bayonet mount. Rotate it counter-clockwise and lift it out of the mount.

Attaching the Lens

Remove the lens' rear protective cover by rotating it counter-clockwise and lifting it off the lens.

6 Getting started

Check that both the camera and the lens are cocked. The lower illustration on page 6 shows the proper position against the index marks for the camera drive shaft (top) and the lens drive shaft (bottom). If the lens is not cocked you can insert a coin or a similar object in the slot and turn the shaft in the direction of the arrow approx. 4/5 of a full turn. You will find that holding the camera body in your left hand and the lens in your right hand as shown in the illustration (top, right) is the easiest way to attach the lens.

When you have aligned the red index on the lens with that on the camera body as shown in the illustration, the lens will fit easily into the bayonet mount. You can then rotate it clockwise until it stops with a faint click as the lens locks in place.

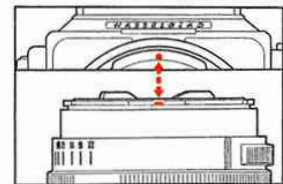
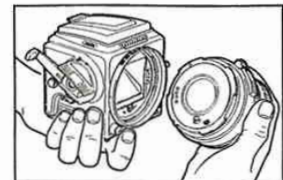

Removing the Lens

Depress the lens catch button, rotate the lens counter-clockwise and lift it out of the bayonet mount.

NOTE: You can only attach and remove the lens when the camera is cocked (fully wound) and not in pre-released mode (see page 20).

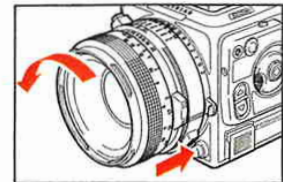

Getting started 7

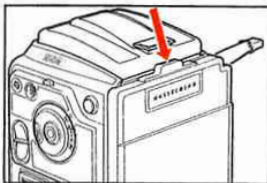

Rear Protective Cover

Depress the catch, tilt the cover backwards and lift it off.

Always keep the rear protective cover on to protect the shutter curtain when the magazine is detached!

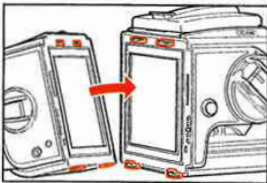

Attaching the Magazine

Ensure that the magazine slide is fully inserted and that the magazine status indicator is white. If the indicator is red, then follow the instructions on page 9. Rest the magazine on the magazine supports with the support lugs properly engaging the recesses in the magazine bottom. Carefully swing the magazine towards the camera body, checking that the magazine hooks fit into the slots in the magazine. Push the magazine gently but firmly against the hooks while sliding the magazine catch to the right.

Release the button when the magazine makes contact with the camera body and then push the button to the left to ensure that it has reached the locked position. Remove the slide to positively lock the magazine to the camera body.

8 Getting started

Removing the Magazine

It is advisable to have the camera fully wound and the magazine status indicator showing white. If the indicator shows red, then follow the instructions below.

Insert the magazine slide fully and with the hinge towards the front of the camera. Slide the magazine catch to the right, tilt the magazine back and lift it off the supports.

NOTE: The magazine cannot be removed without inserting the magazine slide. The slide protects the film from fogging. Note also that the camera cannot be operated when a magazine with the slide inserted is attached to the camera.

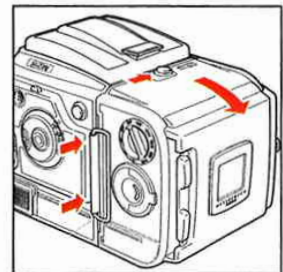

The Magazine Status Indicator

The status indicator on the right hand side of the magazine shows whether the magazine is ready to operate (white) or not (red), i.e. the film has not been advanced. Do not attach a magazine showing white to a camera that is not re-cocked! Wind it first, otherwise you will lose one frame. Do not attach a magazine showing red to a fully wound camera! That could result in an unintentional double exposure since the frame in position in the magazine probably already is exposed.

If the status indicator shows red, release the camera (page 17) before attaching the magazine. Then, when you wind the camera, the film will be advanced one frame.

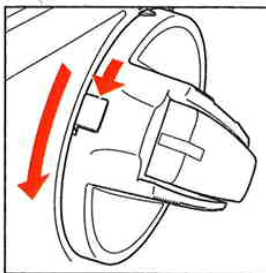
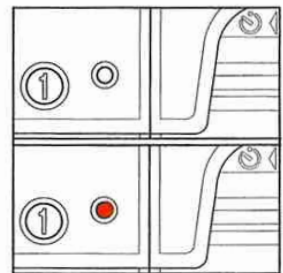

The Winding Crank

One full revolution of the winding crank winds the camera, cocks the lens mechanism and transports the film to the next frame.

Underneath the crank are the drive shaft and the bayonet mount for the Hasselblad Winder (pages 74, 76), which can be attached after removing the crank. It is recommended that the camera is fully wound when the crank is removed or replaced.

Removing the Winding Crank

To remove the crank push the catch lever on the rear of the crank hub downwards while rotating the crank counter-clockwise. Then pull it straight out from the shaft.

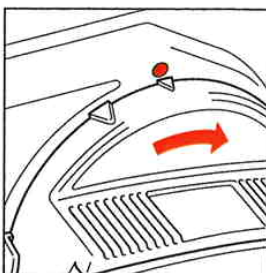

Attaching the Winding Crank

On the side of the crank hub are two triangular index marks, a larger one and a smaller one. Attach the crank to the shaft with the smaller mark aligned with the red dot, located immediately above the mount. While pushing the crank against the camera body, rotate it clockwise until the larger mark is aligned with the red dot.

10 Getting started

Strap and Strap Lugs

The 203FE is delivered with a medium wide shoulder strap, packed separately. You will find other types of straps in the Hasselblad Product Catalog. All straps are provided with special clips for easy attaching and removing of the strap.

Attaching the Strap

Place the main body of the strap clip from behind over the strap lug on the camera with the strap pointing backwards (see fig.). Press the tip of the clip towards the camera while pulling the strap to slide the clip over the lug to the locked position.

Removing the strap

Hold the strap pointing backwards and lift the locking plate of the clip high enough to pass over the top of the lug. Push the clip forwards to slide it off the lug.

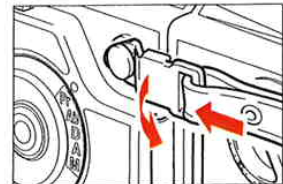
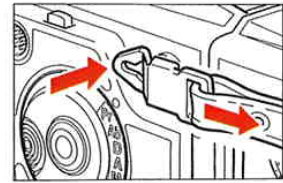
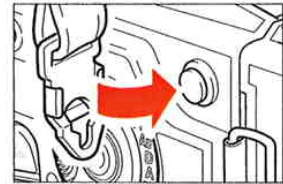

Getting started 11

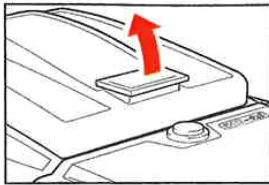

Focusing Hood and Magnifier

Opening the Focusing Hood

Lift the lid with a firm grip on the tab at its rear edge and swing it up to a vertical position. The hood unfolds automatically and locks in open position.

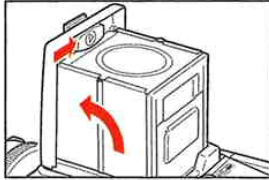

The Built-in Magnifier

Use the built-in 4x magnifier to enlarge the viewfinder image, e.g. for more accurate focusing. To unfold it, push the oval catch inside the lid to the right, as indicated in the illustration.

To fold the magnifier down, simply push it back towards the lid until it locks.

The magnifier can easily be exchanged for one with a suitable correction lens to match your individual eyesight (see page 26).

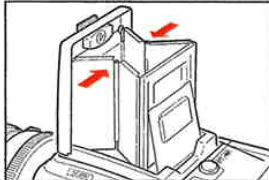

Closing the Focusing Hood

"Pinch" the side plates at the hinge points and fold the hood back down.

12 Getting started

Viewfinder Image and Display

Focusing Screen

The Hasselblad 203FE is equipped with the Acute-Matte focusing screen featuring the highest brightness and resolution among the Hasselblad focusing screens. The center of the screen is indicated by a hairline cross. A circle of dots indicate the metering area used by the built-in selective meter. See page 27 how to change the focusing screen.

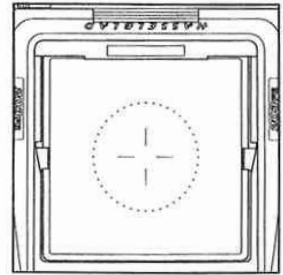

The Exposure Meter

The exposure meter is a center weighted selective meter where the metered value derives from a approx. circular Ø 28 mm central area corresponding to 20% of the total image area. The metering range for a film speed of ISO 100/21° extends from EV 0.5 to EV 21.5 at f/2.8.

The Viewfinder Display

Located above the upper edge of the viewfinder image is the display, which is the information center of the camera. You find a comprehensive description of the display and its symbols on pages 18-19.

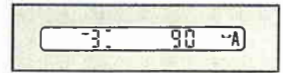

Getting started 13



The Control Panel

The control panel occupies most of the left hand side of the camera body. It includes all the controls for the various functions of the 203FE, such as:

- The Flash Connectors
- The Display Illumination Switch
- The Mode Selector Dial
- The Adjustment Buttons

Flash Connectors

The flash connectors are located underneath the protective cover in the upper forward corner of the control panel. The smaller one is a standard PC-socket and the larger one is a 6-pin connector for TTL-controlled dedicated flash units.

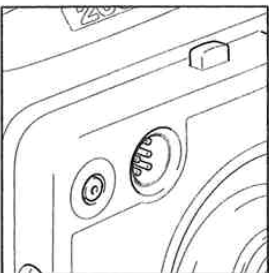

The PC-socket

Non-dedicated flash units and certain adapters should be connected to this socket.

The Dedicated Flash Connector

A dedicated flash unit connected to this 6-pin outlet directly or through a suitable adapter will be fully controlled by the camera processor.

You find detailed information on flash photography on pages 59-71.

The Display Illumination

Pressing the button above the flash connectors turns the display illumination on or off. The switch has a toggle function. It works only when the camera is activated.

14 Getting started

The Mode Selector Dial

With the mode selector dial you can select any of the five operating modes **Pr**, **Ab**, **D**, **A** or **M** available in the 203FE. The **Ab**, **D**, **A** and **M** modes are used for photography and **Pr** for the programming of certain functions.

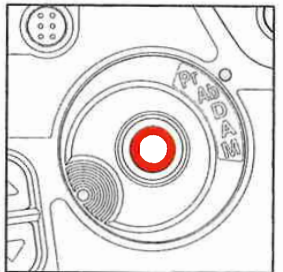

The Automatic Exposure (AE) Lock

In the center of the mode selector dial is a push-button, marked with a red circle. It operates the AE-lock and certain other functions, depending on the setting of the mode selector dial. You can also use it to start the electronic operating system in the camera.

The Adjustment Buttons

These keys also have multiple functions depending on the setting of the mode selector dial.

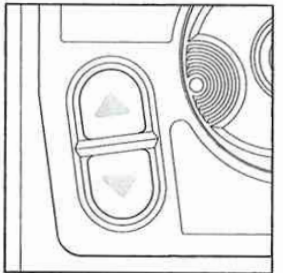

The functions of the mode selector dial, the AE-lock and the adjustment buttons are described in detail on the pages 28-29.

Getting started 15

Left Hand Grip

Holding the 203FE in your left hand with your index finger on the release button, as shown in the upper illustration below, is the most convenient grip. You can reach the AE-lock and the adjustment keys with your left thumb (lower illustration below) and your right hand is free for focusing, aperture setting, operating the crank or changing the lens or the magazine.

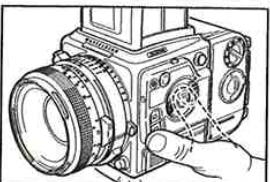
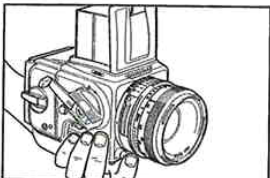

16 Getting started

Activating the camera and the metering system

Before you operate the 203FE you have to wind the camera to cock the shutter (if it is released) and switch on the metering system. To be able to release it you also have to remove the magazine slide.

The fully wound 203FE can be switched on in two different ways:

1. By depressing the exposure button half-way in, i.e. to the "pressure point".
2. By depressing the AE-lock button.

Activation as per 1. above can only be performed when the magazine slide is removed. At normal light levels this activation occurs when the exposure button is depressed for an exposure.

At low light levels the camera should always be activated well before releasing the exposure in the automatic modes (Ab, D and A).

Activation as per 2. is not possible if the AE-lock has been kept depressed for more than 16 seconds.

Keep the magazine slide inserted when you wish to avoid unwanted battery power consumption caused by unintentional activation of the metering system.

The electronic system and the viewfinder display turn off automatically 16 seconds after the last key or button operation, but all relevant data are stored in the memory.

Focusing, Exposure Release and Viewfinder Display

Turn the focusing ring (page 31) until the image of the subject appears sharp in the viewfinder.

Depress the exposure button to the pressure point (half-way in).

If the mode selector dial is set in **Ab**, **D** or **A** position the display now shows – besides a few other symbols described in the following section of this manual the preselected aperture and the shutter speed calculated by the camera computer. With the mode selector set at **M** the display shows the letter **M**, the pre-selected aperture and the shutter speed set on the shutter speed ring. If the exposure button is released again, the display instead shows the selected shutter speed and the difference in EV between the metered and the manually set values.

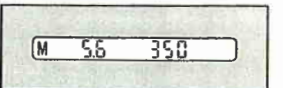
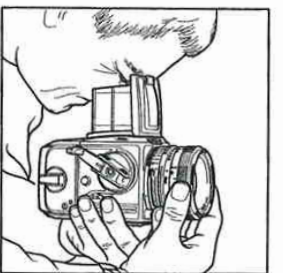

You can now press the exposure button all the way in to make the exposure. After releasing the button you can rotate the winding crank one full turn until it locks, to rewind the camera and advance the film one frame.

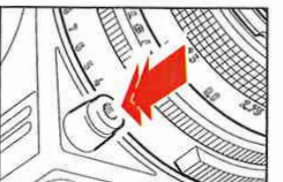

Getting started 17

Operating details



Viewfinder Display & Symbols

The display is shown in the illustrations the way it is built into the camera body. When you use a prism viewfinder the display appears reversed, but the microprocessor adjusts all the indications to make them fully readable.

	Flash Ready Signal The flash symbol is illuminated green when a dedicated flash is connected, turned on and ready to be fired (pages 56, 82).
M	Manual Mode The mode selector dial is set at M (page 52).
	Selftimer Function Flashes when the selftimer is activated. Appears also by programming the selftimer delay in Pr mode (page 39).
DIFF	Differential Mode The mode selector dial is set at D (page 49).
	Plus / Minus Sign Appears together with a correction or deviation value when the mode selector dial is set at Ab , D , A , or M and in certain Pr functions. The r.h. plus/minus sign can also be displayed together with the "Flash ready signal".

18 Operating details



Figures

Eight 7-segment figures indicate corrections, deviations, EV, shutter speed, aperture and certain other information in operation modes **Ab**, **D**, **A** and **M** as well as programming functions in **Pr** mode and certain warnings in various modes of operation.

Fraction Indication

One or two dashes to the right of the figure indicate 1/3 and 2/3 step higher value than indicated by the figure.

Minutes Indication

A vertical dash to the right of the figure indicates that the preceding figure shows the number of minutes at shutter speeds of 60 s or slower.

Film Speed

Indicates film speed set on E- (or TCC-) magazine dial or inserted manually in **Pr** mode (pages 40, 41). **S** in **ISO** is also used to indicate **seconds** at very slow shutter speeds (0,7 s to 60 s) or long exposures (1'30 s to 34').

Battery Check

Appears when battery capacity is low (page 58).

Magazine Check

Indicates that the attached magazine is not a E- (or TCC-) magazine.

Automatic Mode

Indicates that the mode selector dial is set at **Ab** (page 44) or **A** (page 51).

Warning Symbol

Flashes red together with one or more of the other symbols to indicate various problems (pages 58, 59).

Operating details 19

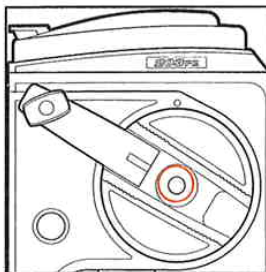

The Right Hand Side

On the right hand side of the camera body are the winding crank, described on page 10, and the pre-release and selftimer lever.

Double Exposure

You can make double (or multiple) exposures by rewinding the camera without advancing the film. This is possible by depressing the double exposure button in the center of the crank hub and simultaneously turning the crank slightly clock-wise. Then you can release the button and complete the winding until the crank locks.

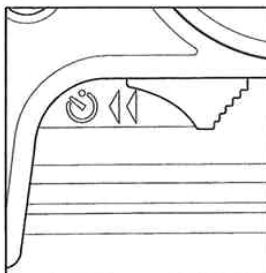

Mirror and Mechanism Pre-release

By pre-releasing certain camera functions and lifting up the mirror you can avoid camera vibrations, reduce the sound level and shorten the time delay between the depressing of the exposure button and the very exposure release. Pre-releasing is done by actuating the pre-release lever **once**. To reset the mechanism and lower the mirror again you perform the operation for a double exposure as described above.

Since the mirror is lifted the light metering is interrupted and locked on the latest recorded value.

20 The Right Hand Side

The Selftimer

Pressing the pre-release lever a **second** time starts the selftimer function. This is indicated by the selftimer symbol in the viewfinder display and by a flashing red light on the camera body to the left of the lens mount. The standard delay in the selftimer is 10 s but it can be set in intervals between 2 s and 60 s in the **Pr** mode (pages 39,42). At the beginning of the delay the light flashes twice per second, but when two seconds remain of the delay time it increases to four times per second and changes to a continuous light during the last half second. You can interrupt the selftimer function at any time by pressing the pre-release lever again or by a "blind" rewind as for double exposure. The selftimer function is inoperative when the shutter speed ring is set in positions **B** or **C** (pages 22, 23).

The Grip Cushion

A rubber cushion along the lower edge of the right hand side provides a safe and comfortable grip.

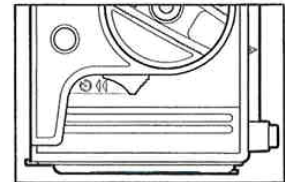
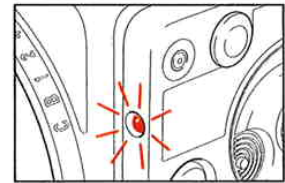
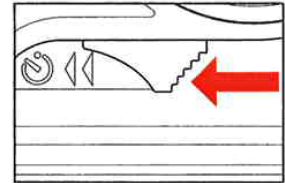

The Right Hand Side 21

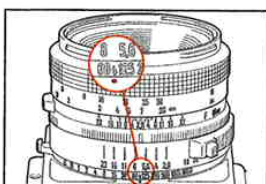

The Front

The Shutter Speed Ring

The shutter speed ring for the focal plane shutter in the 203FE has speed markings from 1 s to 1/2000 s as well as **B** and **C**. Between the markings are intermediate half speed click stop settings. One of these settings - 1/90 s, marked with a flash symbol - is the fastest shutter speed for flash synchronisation with the focal plane shutter (page 60). In all modes of operation except **M** the camera processor automatically calculates and sets the shutter speed within the range 90 s to 1/2000 s, irrespective of the shutter speed ring setting.

Long Exposure:

If you require a shutter speed slower than 90 s you have to switch to **M** mode and depress both correction buttons (page 29). This "inverts" the meaning of the split-second markings on the shutter speed ring, i.e. 30 means 32 s etc. until 2000, meaning 2048 s (34 min.). The "inversion" remains as long as the camera is active and 4 sec. after auto-shut-off, or until you change mode or depress both correction buttons a second time.

In the **B** setting in all modes the display continuously shows the elapse exposure time in full seconds up to 60 minutes. The setting marked **C** is used together with **CF** and **C** lenses only (Appendix A, page 85).

NOTE: When the mode selector dial is set at **M** (page 52) the display indicates the accurate shutter speed for the intermediate settings.

22 The Front

Exposure Release Button

In the lower right hand corner of the front, within comfortable reach with the left hand grip, is the exposure release button. The button has four different functions:

- A. When depressed to the "pressure point":
 1. Activate the camera.
 2. Change the display to indicate aperture and shutter speed.
 3. Lock the light value in **Ab** and **A** mode
- B. When depressed all the way in:
 4. Release the shutter to make the exposure with preset or calculated values.

The exposure button is locked when the magazine slide is in the magazine.

Cable Release

When using shutter speeds slower than 1/30 s you are recommended to put the camera on a tripod and use a cable release, screwed into the threaded mount in the center of the exposure release button. The cable release and the exposure button have identical functions.

Lens Catch & Shutter Speed Ring Lock

The lens catch button is located in the lower left hand of the camera front. To release and remove the lens you have to keep the button depressed while rotating the lens clockwise as seen from behind. The button also operates the lock for the shutter speed ring settings **B** and **C**. Keep it depressed when moving the ring to either of these settings. Moving **from B** to 1 is free.

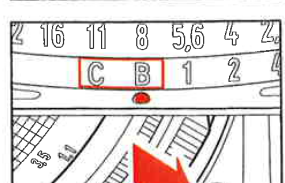
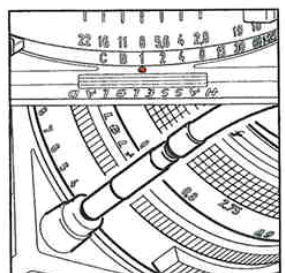

The Front 23

The Rear of the Camera and the Focal Plane Shutter

Avoid leaving the rear of the camera and the shutter curtains unprotected! Always attach the rear protective cover when the magazine is removed!

The opening in the rear of the camera is normally covered by the shutter curtain. The 203FE has a mechanically powered, electronically controlled focal plane shutter with two textile curtains running from left to right across the opening. The running time for the curtains is 1/90 s. In all modes except Manual Mode (pages 39-51) the shutter speeds are calculated by the metering system which controls the shutter. The shutter speeds are adjusted in increments of 1/12 EV-step in the

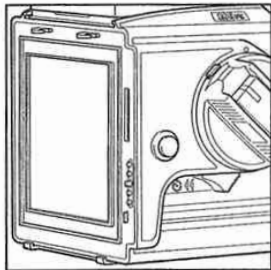

24 The Rear & The Shutter

interval from 1/2000 s to 16 s and 1/4 EV-step in the interval from 16 1/4 s to 90 s, but for practical reasons only the shutter speed for each 1/2 EV-step is indicated in the viewfinder display.

Caution: Whether the shutter is cocked or released, one shutter curtain is always exposed in the opening. When the rear of the camera is not covered by a magazine or a protective cover care should be taken when handling the camera. **Avoid touching the curtain! It is sensitive to damage!**

To the right of the opening are the magazine driving gear and the trigger for the magazine status indicator (page 9). There are also the contact pins for the data bus connection between the magazine and the central processor in the camera body. The contact pins are sensitive to contamination and should not be touched.

At the lower edge of the back are the magazine supports and close to the top are the magazine hooks – both together serving to positively fix the magazine to the camera body (page 8).

The Viewfinder System

Changing the Focusing Hood or Viewfinder

To remove the focusing hood for using any other viewfinder within the TCC system detach the magazine (or the protective cover). Also fold down the focusing hood to avoid damaging it.

Remove the hood by sliding it to the rear in its guide slots. Slide the replacement viewfinder into the slots and push it forward until it stops. When fully inserted the viewfinder is retained in position by a spring-loaded ball latch until you have reattached the magazine or the protective cover.

Changing the Magnifier

The standard 4x magnifier lens plate can be changed for a plate with a correction lens to compensate for individual eyesight. The supplied magnifier marked -1 provides a comfortable viewing of the focusing screen and the display for most users. Correction lenses, however, are available with powers ranging from +3 to -4 diopters.

Change the magnifier as follows:

1. Remove the focusing hood from the camera body and open it by lifting the lid.
2. Release the magnifier by pushing the catch to the left. Push the magnifier halfway down and pull out the lens plate.
3. Keep the plate holder halfway down and insert the replacement lens plate with the printed side up. Fold the hood and put it back on the camera.

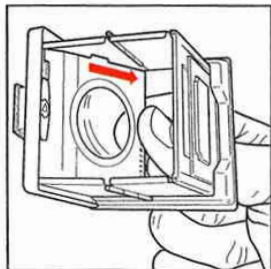
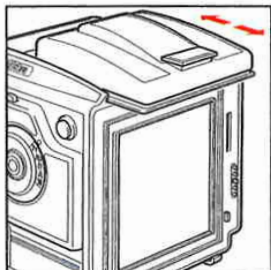

26 The Viewfinder System

The Left Hand Side

The Mode Selector Dial

The mode selector dial is in the center of the control panel at the left hand side. To select any of the operating modes of the 203FE simply turn the dial until the symbol for that particular mode is aligned with the red index mark. The different operating modes are:

- Pr:** Programming Mode
- Ab:** Automatic Bracketing Mode
- D:** Differential Mode
- A:** Automatic Mode
- M:** Manual Mode

The functions of these modes are described in detail on pages 38-53.

The Automatic Exposure (AE) Lock

The AE-lock is the push-button in the center of the mode selector dial, marked with a red ring. It has different functions, depending on the modes of operation as described later. It can also be used to activate the camera's metering system (page 16) except after the AE-lock has been depressed for more than 16 seconds, e.g. if the camera has been laying on the left hand side. In that case the camera can only be activated for normal use by depressing the exposure release button to the pressure point.

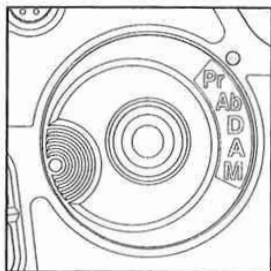

28 The Left Hand Side

The Bottom

At the bottom of the camera are the quick coupling plate, the tripod thread and two ridges, supporting the camera when placed on a flat surface. The quick coupling plate fits the Hasselblad accessories, such as the tripod quick coupling and the flash bracket. The tripod thread is 1/4".

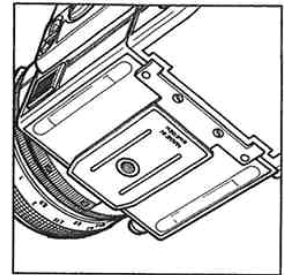

The Top

The viewing components (page 26) occupy most of the camera top. The camera body is supplied with the collapsible focusing hood, which also serves as a protective cover for the focusing screen.

In front of the HASSELBLAD sign is a window for daylight illumination of the viewfinder display screen.

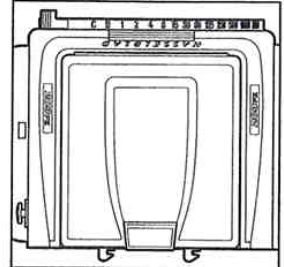

The Bottom & The Top 25

Changing the Focusing Screen

Your 203FE is equipped with the exceptionally bright and sharp Acute-Matte focusing screen. The area inside the dotted circle indicates the area metered by the built-in exposure meter (page 38).

If you wish to replace the focusing screen with any of the other focusing screens in the Hasselblad System, simply follow the procedure below:

1. Detach the magazine and the viewfinder.
2. Push the two screen latches to the side into their recesses.
3. Place your hand over the screen and invert the camera. The screen will now drop into your hand.
4. Insert the replacement screen with the smooth side up and the sharp-edged corners down. Ensure that all four corners of the screen are positively sealed on their supports. You need not return the screen latches. This is done automatically when the viewfinder is replaced.

NOTE: Should the screen refuse to drop out by itself, ensure that the camera is fully wound, remove the lens and check that the mirror is in the down position. Put a finger through the lens mount and push gently at the screen from underneath, preferably with a soft cloth between the finger and the screen.

Always avoid direct light into the viewfinder eyepiece when making an exposure.

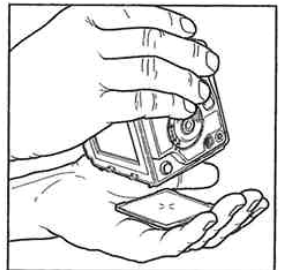
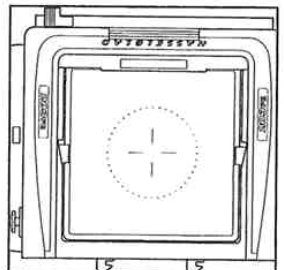

The Viewfinder System 27

The Adjustment Buttons

The adjustment buttons also have different functions depending on the selected mode. With a few exceptions a single push on the upper button increases and on the lower button decreases the value to be adjusted. If you keep the button depressed for more than half a second the value starts to change at a rate of 4-5 steps per second until the button is released.

The Flash Connectors

The larger six-pin TTL-connector provides automatic control of dedicated flash units. The Hasselblad Proflash 4504 can be connected directly to the 203FE but other dedicated flash units may require a suitable adapter, such as the Hasselblad SCA-adapter 390 or 590, between the unit and the camera. The smaller connector is a common PC-socket for any kind of flash unit. You can find further instructions on flash photography with the 203FE on pages 59 and 88.

Display illumination

In low light levels depressing the switch button on the upper edge of the control panel switches on the illumination of the viewfinder display. The button has a toggle function.

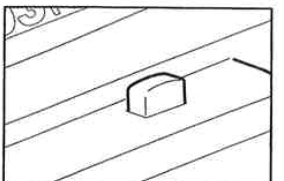
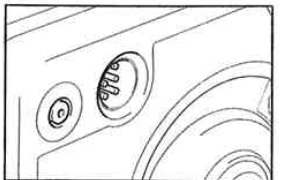
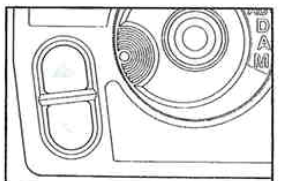

The Left Hand Side 29

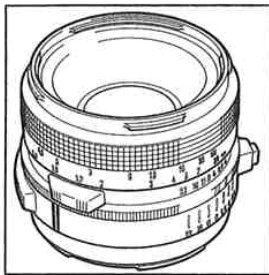

Lenses

The Hasselblad lenses made since 1957 can be separated in two major groups, each with two sub-groups:

- Lenses with a built-in leaf shutter:
 - C lenses
 - CF lenses
- Lenses without shutter:
 - F lenses
 - FE lenses

All these lenses can be used on the 203FE, but only the FE lenses will give you access to the full range of exclusive and sophisticated features of the 203FE.

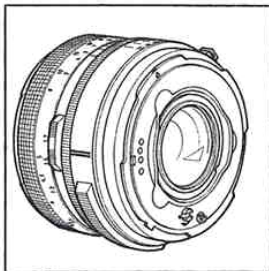

FE Lenses

The Hasselblad FE lenses, which have no built-in shutter, can easily be identified by their system sign, i.e. the blue twin lines on the left hand side of the aperture ring. Another sign, visible only when the lens is detached from the camera body, are the four data-bus contact pins in the bayonet plate at the rear of the lens. They are used for the data transmission between the lens electronics and the electronic system in the camera body. The contact surfaces of these pins are sensitive to contamination and should not be touched with your fingers. Attach the protective cover after removing the lens from the camera and never set the lens down on the unprotected bayonet plate!

30 Lenses, FE Lenses

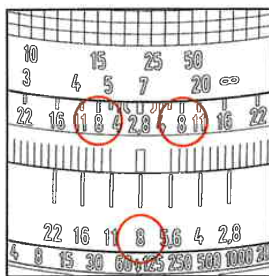

The Depth-of-field Scale

The depth-of-field scale repeats the aperture values on both sides of the heavier index line between the fixed ring with the index line and the focusing ring. When the image is focused on the screen you can read the focusing distance opposite the index line in the depth-of-field scale. The depth-of-field limits can be read opposite the left and right values corresponding to the pre-set aperture value. The illustration depicts the depth-of-field for the pre-set aperture value of 8.

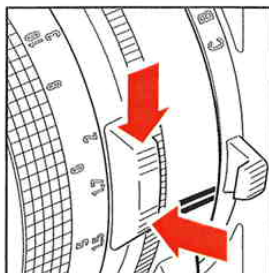

Depth-of-field Preview

The lens is normally set at the largest aperture to provide the brightest possible viewfinder image with the shallowest depth-of-field. You can stop down the lens diaphragm to the pre-set aperture by pushing down the depth-of-field preview knob until it locks. To re-open the diaphragm, depress the lower end of the knob.

32 Lenses, FE Lenses

FE Lens Functions

Setting the Aperture

The aperture ring is the one closest to the shutter speed ring on the camera body. Use it to pre-set the selected f-stop. The full f-stops marked on the ring have click stops, but there are also click stops for each intermediate half f-stop. The set aperture value can be read against the heavy index line on the grooved ring in front of the aperture ring. It will also show on the viewfinder display when you depress the exposure button halfway in, i.e. to the pressure point.

The aperture ring has two grooved grips for handling convenience. One of these grips has a push-button which has no function on the 203FE.

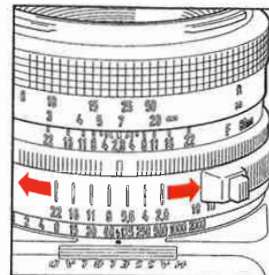

Focusing and Depth-of-field

The focusing ring is the rotating ring with a knurled rubber grip closest to the front of the lens. It has two scales for the focusing distance, the white meter scale and the orange inch/foot scale. Rotate the focusing ring until the image of your subject appears absolutely sharp on the focusing screen.

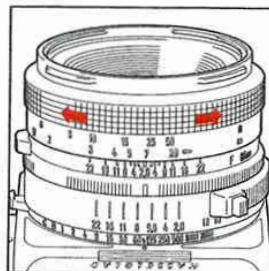

Lenses, FE Lenses 31

Infrared (IR) Photography

Infrared light with wavelengths beyond 800 nm are refracted by the lens to an image plane further away from the lens than the image plane for visible light. When photographing with IR light you have to compensate for this difference by setting the focusing distance at the red IR index to the right of the common index line.

Follow this procedure:

- Focus as usual on the focusing screen.
- Mark or memorize the distance on the focusing scale opposite the common index line.
- Rotate the focusing ring to set this distance opposite the IR index.

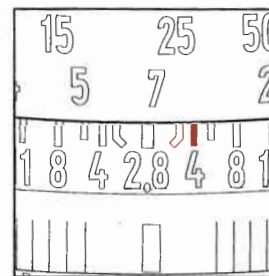

Exposure Value (EV)

The orange scale on the right hand side indicates the exposure value for the set aperture/shutter speed combination. You read the value opposite the orange triangular index on the shutter speed ring. The scale has no particular function on 203FE. Do not confuse the exposure value with the light value stored in the metering system when you depress and release the AE-lock (page 28).

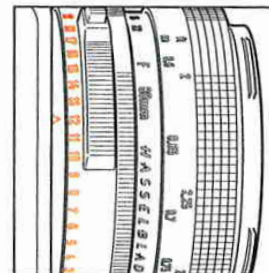

Lenses, FE Lenses 33

Magazine Operation

Loading the Magazine

You can load the magazine with film on or off the camera. With the magazine slide inserted you have to ensure that its flat side is turned towards the magazine body.

Follow the procedure below to load a film:

(cw=clockwise; ccw=counter-clockwise)

- Fold out the film holder key.
- Turn the key cw and withdraw the film holder.
- Place an empty take-up spool under the grooved knob of the spool clamp bar. Insert a roll of film under the other end of the bar, turned as in the picture. Remove all of the paper band surrounding the roll!
- Turn the film holder key cw to open the film clamp. Pull 8-10 cm (3-4 in.) of paper backing off the film roll. Slide the side edge under the clamp.
- Insert the tongue of the backing paper into the slot in the take-up spool.
- Turn the grooved knob cw to align the arrow on the paper with the triangular index on the bar, but no further.
- Turn the film holder key ccw. Insert the film holder into the magazine. Ensure that it is correctly positioned. Turn the film holder key cw to lock the film holder in the magazine.
- Fold out the film winding crank. Rotate it cw about ten turns until it stops. Turn it ccw and fold it in.

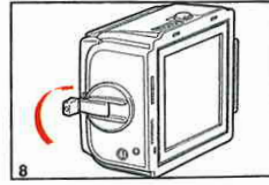
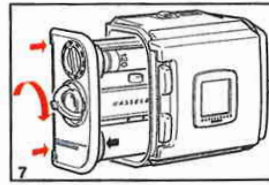
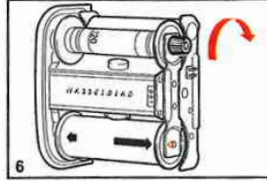
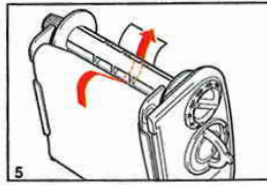
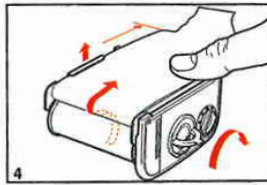
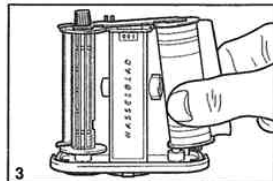
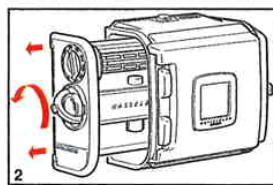
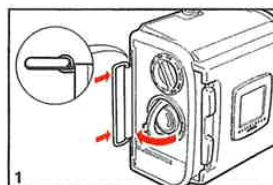

Number 1 will now be displayed in the frame counter window indicating that the loaded magazine is ready for use.

The film winding crank is blocked at frame 1 only. It can be used to wind a partially exposed film at any frame after that.

The frame counter is automatically reset when the film holder is withdrawn from the magazine.

34 Magazine Operation

Magazine Operation 35

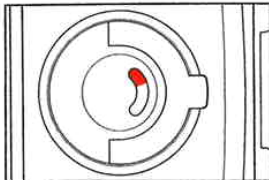

Magazine Load Status

In the center of the film holder key there is a crescent-shaped indicator window that shows white when the magazine is freshly loaded. It gradually changes to red as the film is wound through. An all red indicator shows that the film is used up or that the magazine is empty.

Removing the Film

After the last frame has been exposed and the film advanced, the magazine blocks the camera against further release. To remove the exposed film fold out the film winding crank and rotate it clockwise until you can feel that the film is leaving the supply spool. Withdraw the film holder from the magazine and remove the film.

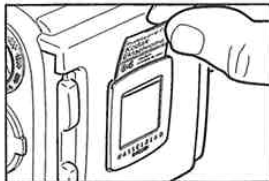

Film Tab Holder

The end tab of the film pack can be inserted in the holder on the back of the magazine as a reminder of the kind of film that has been loaded into the magazine.



Film Speed Dial

On the left hand side of the magazine above the film holder key is the film speed dial. The speed set on this dial is automatically transferred to the metering system in the camera body and displayed in the viewfinder in the Pr mode (page 43). The range of the film speed dial extends from ISO 12 to ISO 6400 with 1/3 and 2/3 intermediate settings.

203FE Selective Metering System and Operating Modes

Pages 28 and 29 described in short how you can select the various operating modes of the 203FE. The description included, also in short, the function of the different controls on the control panel and how to use them. The following section describes in detail the metering system and the different operating modes.

The Metering System

The different methods to start the camera and activate the metering system are described on page 16. The system turns off automatically 16 seconds after the last button operation.

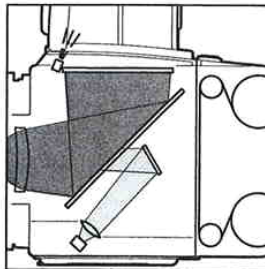

The selective light meter is the most important feature in the metering system. The metering area is indicated by a circle of dots in the center of the focusing screen. The circle has a diameter of 28 mm which is approximately 20% of the total image area.

The meter is very sensitive and accurate. It measures the light reflected from the subject within the metering area, applying a soft integral method, and has a limited reaction to light from outside that area. Thus, even minor displacements of the metering area may result in unexpected changes in exposure values.

NOTE: Like all other reflection exposure meters the selective meter is adjusted to give an exposure value that in the end produces an 18% grey tone, no matter if the metered subject is black, grey, white or of any color. If the metered area is brighter or darker than this 18% grey the metering result has to be adjusted manually up or down to obtain the picture result.

The value that is stored in the metering system is the **light value**. This means that the shutter speed calculated by the system is adjusted automatically if the pre-set aperture or the film speed is changed. The working shutter speed is adjusted in 1/12 alt. 1/4 EV-steps (see page 24), i.e. much more accurate than the half speed steps that for practical reasons are used on the viewfinder display.

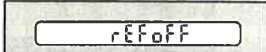
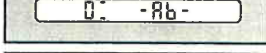
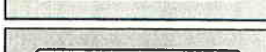
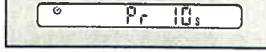

Functions:

Pr1 To set the film speed when you are using standard film magazines. Speed values can be set from 12/12° ISO to 6400/39° ISO in 1/3 EV step (1° ISO) increments. The standard setting is 100/21° ISO.

Pr2 To set the selftimer delay in the range from 2 seconds to 60 seconds. The available values are: 2, 4, 6, 8, 10, 12, 14, 16, 20, 30, 40, 50, 60 seconds. The standard setting is 10 seconds.

Pr3 To adjust the automatic flash metering function, facilitating the use of fill-in flash. The setting range is -3 to +1 EV in 1/3 EV increments. The standard setting is 0.

Pr4 To set the exposure shift in the **Ab** mode for automatic bracketing. The shift has four different settings: 0, 1/3, 2/3 and 1 EV. The standard setting is 2/3 EV.

Pr5 To switch the reference metering function On/Off and to set the warning levels for reference metering in **M** mode. The standard setting is **Off**.

How to use the "Pr" Mode

The Programming Pr mode can be selected whenever the circumstances require a change of the standard values listed above, or a change of previously made settings. The changed values are effective as soon as they are entered.

Magazine Slide Pocket

On the rear of the magazine is the slide pocket where the magazine dark slide could be stowed away when not in use. Turn the slide with the hinge towards the rear to fold the bow fully into the slide pocket recesses.

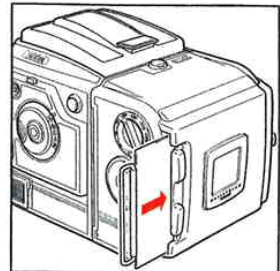

Film Plane Index

Close to the magazine front and moulded into the rubber grip cushion is the film plane index. It can be used to measure the subject-to-film distance when the exact figure is required, e.g. in close-up photography.

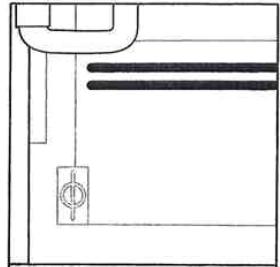

Other concepts used in this manual are **continuous metering** and **continuous indication**. This means that the system continuously meters the light from the part of the subject which at that very moment lies within the metering area and also continuously updates the value displayed in the viewfinder.

Flashing numbers or symbols in the viewfinder indicate that a warning function has been triggered. See pages 54 and 55 about warnings!

Operating Modes

The different operating modes are described in the order they appear on the Mode Selector Dial.

Pr Programming Mode

The Pr mode is not an exposure mode but used to enter certain user defined values, different from the **standard settings**, which are built into the camera. The standard settings are always set when you activate the system after the battery has been removed or if no other values are stored from previous operations. Any change made in the Pr mode is effective until changed again or until the battery is removed.

The Pr mode is not intended for photographing. If you make an exposure with the camera in Pr mode, the camera automatically shifts to **A** mode and then immediately back to Pr mode after the exposure.

NOTE: Pre-releasing the camera (page 20) in any of the operating modes always locks the light value that is present at the moment of lifting the mirror.

In the illustrations changing indications are noted with grey symbols and flashing indications by rays around the symbol!

NOTE: After a battery change the system always returns to the standard settings and all previously entered values are lost

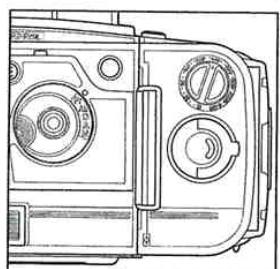

By repeatedly pressing the AE-lock button you can shift through the Pr-functions in the sequence Pr1->Pr2->Pr3->Pr4->Pr5->Pr1->etc. The sequence always starts on the last used function except after a battery change. In Pr mode the camera can be started by depressing either the exposure release button to the pressure point or the AE-lock button.

Setting the Film Speed (Pr1 function)

Setting the film speed in Pr mode is possible only when a common A-magazine is used. This is indicated on the display by the symbol "Pr" before the film speed value. With an E-magazine the film speed is set on the magazine dial (page 36), the Pr1 function is inactive and the display shows the magazine dial setting only.

1. Set the Mode Selector Dial in the Pr position.
2. Depress the AE-lock button to start the camera and then repeatedly if required to select the Pr1 function.
3. Press the adjustment buttons to change the film speed value. The upper button increases and the lower decreases the value in steps of 1/3 EV.
4. Reset the Mode Selector Dial to the desired exposure mode or press the AE-lock button to switch to next Pr-function.

NOTE: A film speed value manually inserted in the Pr1 function is stored until changed again by the same procedure (or until the battery is removed).

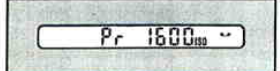
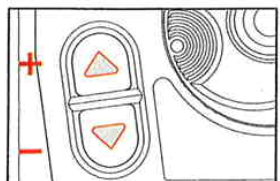
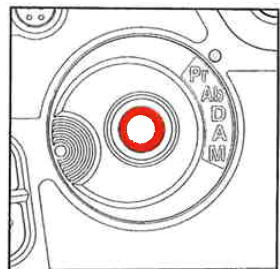

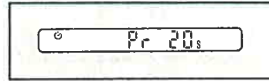
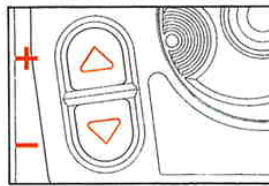
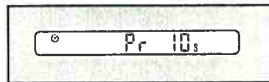
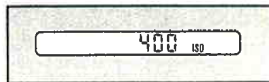

If an E- (or TCC-) magazine is attached the film speed set on the magazine dial overrides the stored value. When the magazine is detached the stored value is automatically recalled. Thus it is easy to shift between E-magazines and common magazines with films of different speeds (e.g. Polaroid films).

Setting the Selftimer Delay (Pr2 function)

1. Set the Mode Selector Dial in the Pr position.
2. Depress the AE-lock button to start the camera and then repeatedly if required to select the Pr2 function.
3. Press the adjustment buttons to change the selftimer delay. The upper button increases the delay and the lower button decreases it with the predetermined steps (Pr2, page 40).
4. Reset the Mode Selector Dial to the desired exposure mode or press the AE-lock button to switch to next Pr-function.

Adjusting the Automatic Flash Metering (Pr3 function)

The function is used to introduce a fixed adjustment in the automatic flash control to reduce or increase the flash power, e.g. for fill-in flash applications.

1. Set the Mode Selector Dial in the Pr position.

42 Operating Modes, Programming Mode

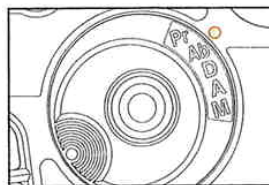
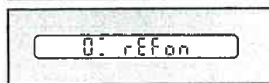
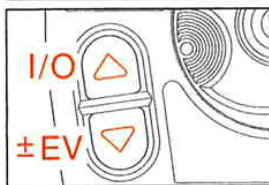

Operating the Reference Metering (Pr 5 function)

In Pr mode the reference metering function can be switched on or off and the warning levels can be established.

1. Set the Mode Selector Dial in the Pr position.
2. Depress the AE-lock button to start the camera and then repeatedly if required to select the Pr5 function.
3. Use the upper adjustment button as a toggle switch to switch the function on or off.
4. Press the lower adjustment button to set the desired warning levels with 1/3 EV increments within the 1/3 to 3 EV range. The value is a ± value, symmetrical with the 0 level. Setting 0 disables the warning function.
5. Reset the Mode Selector Dial to the desired exposure mode or press the AE-lock button to switch to next Pr-function.

Ab Automatic Bracketing Mode

Function: Automatic exposure with aperture priority, pre-selected film speed and automatically calculated shutter speed. Exposure bracketing with 0, 1/3, 2/3 or 1 EV-step preselected bracket increments.

Features: Continuous metering of the light value. Locking and storing of the light value at a selected moment by keeping the exposure

44 Operating Modes, Programming Mode

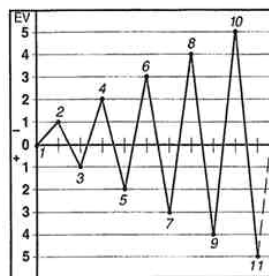

metered and stored light value. Thus, after 21 exposures there is no more shift in the exposure values. During the bracketing operation the light meter is disabled.

The value of the shift step should be preset to any of the steps 0, 1/3, 2/3 or 1 EV in Pr mode (page 43). Default value is 2/3 EV, which gives a total exposure span of 6 2/3 EV. With a shift step of 1 EV the max. total span is as large as 10 EV. If any of the shutter speed limits (90 s or 1/2000 s) is reached during bracketing that speed will be repeated until the operation is terminated.

For an exposure sequence without any bracketing shift the zero step should be selected, but in that case the "A" mode is recommended.

Suggested procedure:

1. Pre-set the desired bracketing shift value using the Pr4 function (pages 40, 43)
2. Pre-set the film speed. With an E- (or TCC-) magazine, set the film speed dial (page 36). With a standard magazine use the Pr1 mode to enter and store the film speed (page 41). Pre-set the desired aperture.
3. Set the Mode Selector Dial at Ab and aim the camera to locate the metering area on a selected subject part.
4. Start the metering system by depressing the exposure release button (page 23) to the "pressure point". The display shows the pre-set aperture, the letter "L" to indicate that the displayed shutter speed (calculated from that aperture, the pre-set ISO

46 Operating Modes, Automatic Bracketing Mode

2. Depress the AE-lock button to start the camera and then repeatedly if required to select the Pr3 function.
3. Press the adjustment buttons to set the desired correction value within the -3 to +1 EV range. Pressing the upper button increases the value and pressing the lower button decreases the value.
4. Reset the Mode Selector Dial to the desired exposure mode or press the AE-lock button to switch to next Pr-function.

NOTE: If the selected adjustment, combined with the selected film speed, takes the flash metering system outside its operative range (ISO 25 - 1000), the display starts flashing.

Setting the Automatic Bracketing shift value (Pr4 function)

1. Set the Mode Selector Dial in the Pr position.
2. Depress the AE-lock button to start the camera and then repeatedly if required to select the Pr4 function.
3. Press the adjustment buttons to change the exposure shift. Pressing the upper button increases the value and pressing the lower button decreases the value. The indicated step value is a ± value (page 44).
4. Reset the Mode Selector Dial to the desired exposure mode or press the AE-lock button to switch to next Pr-function.

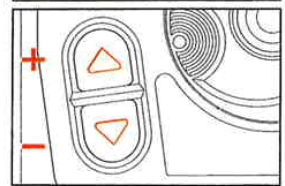
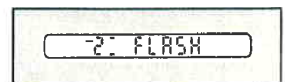
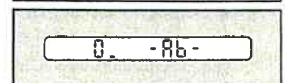
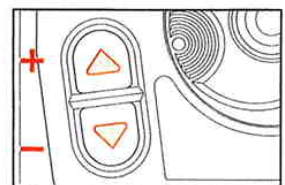

Operating Modes, Programming Mode 43

button at the pressure point. Permanent preselected adjustment of the continuous or stored light value ±5 EV-steps in 1/3 EV-step increments.

How to Use the "Ab" Mode

For the best utilization of the sequential Ab mode you are recommended to use the Hasselblad winder accessory.

The selective meter in the 203FE is very sensitive and reacts to the smallest change in the light level within the metering area (pages 13 and 38). The shielding of the sensor makes it much less sensitive to light outside that area. The metering area should be located on a suitable subject part and the changing readings in the viewfinder display carefully observed before storing the reading or releasing the exposure.

Exposure bracketing is very useful when the subject is difficult to meter or when the possibility to make an accurate determination of the exposure value is limited. Bracketing is best performed by using of the winder for the smoothest operation.

The camera runs as long as the exposure button is kept depressed or until the film is finished, and for each exposure after the first one the shutter speed is changed according to the preset shift step value. The second frame gets one step more exposure (lower EV); the third one step less (higher EV); the fourth two steps more; the fifth two steps less; and so on.

The bracketing shift function is limited to 10 exposures above and below of the originally

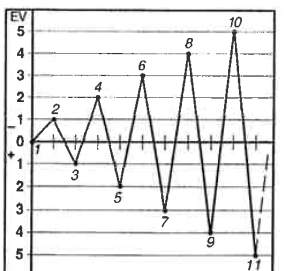
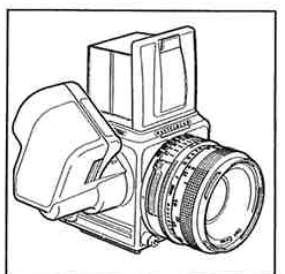

Operating Modes, Automatic Bracketing Mode 45

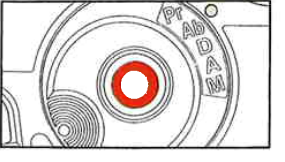
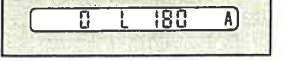
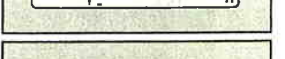
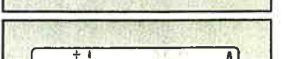
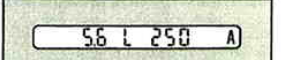
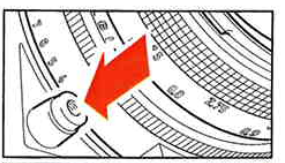

value and the metered light level) is locked in the metering system, and an "A" for Automatic Mode. When you release the button the aperture figures are replaced by a figure, that shows the stored exposure correction. The system changes to the continuous metering state and the shutter speed figures keep changing when the metering area is moved about. If the display goes out, the system is re-activated by depressing the exposure button half-way again.

Depressing the exposure button fully at this stage releases an exposure with the shutter speed that was locked and stored when the exposure button reached the pressure point on the way in.

NOTE: The system can also be started by depressing the AE-lock button. It then reacts as described in p.5 below. Depressing the AE-lock button erases all previously stored exposure information.

5. Depress and release the AE-lock button to lock and store the exposure of a selected subject area. The display shows the stored shutter speed, "L" for locked and "0" for "no adjustment". If the aperture or ISO setting is changed the shutter speed adjusts automatically.

NOTE: Depressing the exposure button resets the system to p.4 above.

6. Use the adjustment buttons (page 29) to adjust the stored exposure if necessary. The display shows the + or - amount of

Operating Modes, Automatic Bracketing Mode 47

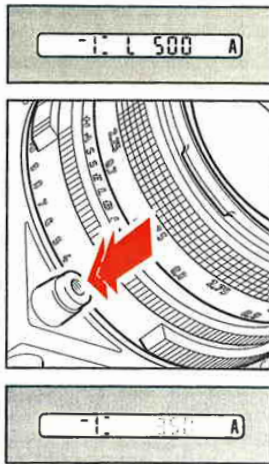

adjustment in 1/3 EV-step increments (page 19). The adjusted shutter speed is shown with 1/2 speed-step increments although the shutter speed is actually adjusted in 1/3 steps.

NOTE: "+" adjustment **decreases** and "-" adjustment **increases** the shutter speed. Any adjustment made with the adjustment buttons remains stored after exposure release until next time the AE-lock button is depressed.

- Depress the exposure button fully to make an exposure according to the stored (and corrected) values.
- Keep the exposure button depressed to make a sequence of exposures with the shutter speeds changing according to the preselected bracketing steps. The original exposure data remain on the display and the metering system is deactivated until the exposure button is released and the camera rewound after the last exposure. When the exposure button is released the metering system is then reset to continuous metering with the latest adjustment parameters.

48 Operating Modes, Automatic Bracketing Mode

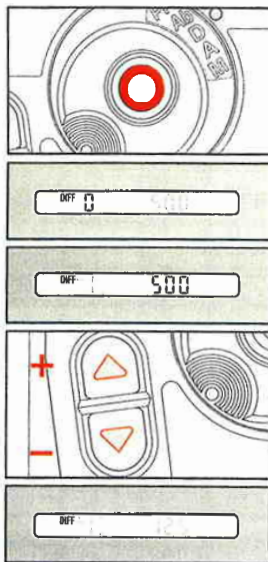

the camera to place the metering area on a selected subject part.

- Depress the AE-lock button to start the metering system. The viewfinder display shows the symbol "DIFF", the figure "0" and the shutter speed (calculated from the pre-set aperture, the ISO setting and the metered light level) continuously changing the speed as the metering area is moved to brighter or darker subject parts.
- Release the AE-lock button to lock the exposure value and the shutter speed on a selected "reference" subject part considered to have the desired "normal" brightness. As the metering area is moved to other subject parts the display continuously shows the brightness difference in + or - EV between the reference part and the present location of the metering area with an accuracy of 1/3 EV-step.
- Use the adjustment buttons to adjust the exposure up or down to the desired level with 1/3 EV increments. You can display the pre-set aperture by depressing the exposure release button to the pressure point, and you can change it if required. The shutter speed adjusts automatically to the new aperture setting, keeping the exposure unchanged.
- Depress the exposure release button fully to make an exposure.
- Rewind the camera to cock the shutter and advance the film to the next frame with the previous exposure values and adjustments maintained.

50 Operating Modes, Differential Mode

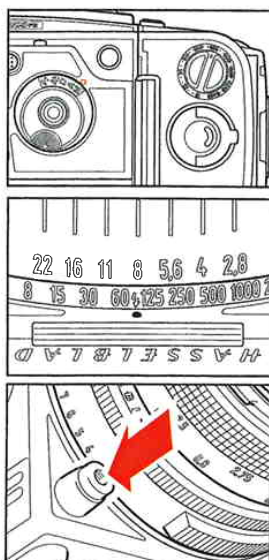

M Manual Mode

Normal exposure, reference function off.

Functions:

Manual pre-setting of aperture as well as shutter speed.

Features:

Completely manually controlled exposure. Continuous metering of the light value. Continuous indication of the difference in EV between the pre-set exposure and the exposure calculated by the camera's CPU.

How to Use the "M" Mode

The M Mode is completely manual. The metering system is working, but it does not change the shutter speed (the aperture is always pre-set manually). The display indicates the calculated "normal" exposure for the metered subject part, but the exposure will be executed according to the manual settings made.

Suggested procedure:

- Pre-set the film speed with the film speed dial on the E- (or TCC-) magazine or using the Pr mode with a standard magazine. (This point may be omitted but is required for a correct indication on the viewfinder display).
- Set the Mode Selector Dial at M.
- Set the aperture and the shutter speed manually.

52 Operating Modes, Manual Mode

D Differential Mode

Functions:

Automatic exposure with aperture priority, pre-selected film speed and calculated shutter speed.

Features:

Continuous metering of the light value. Locking and storing of the light value in a selected moment. Continuous indication of the difference between the stored and the presently metered light value. Adjustment of the stored light value ± 5 EV-steps in 1/3 EV-step increments.

How to Use the "D" Mode

The Differential D Mode is very convenient when you want to find out the contrast range of a subject. By locking and storing the light values on one subject part and then moving the metering area about the subject, the display continuously shows the contrast difference between the initially metered part and the present location of the metering area. The stored light value remains for any number of exposures until intentionally replaced or adjusted.

Suggested procedure:

- Pre-set the film speed. With a E- (or TCC-) magazine set the film speed dial (page 36). With a standard magazine use the Pr mode to insert and store the film speed (page 41).
- Pre-set the desired aperture.
- Set the Mode Selector Dial at D and aim

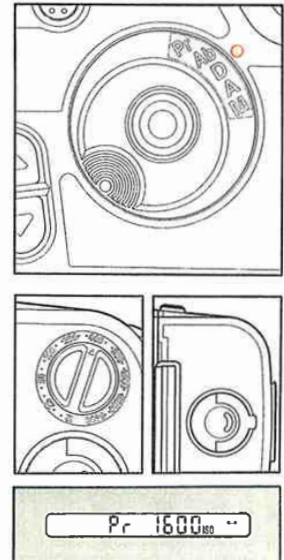

Operating Modes, Differential Mode 49

NOTE: The metering system can also be started by depressing the exposure release button. It then recalls the latest stored exposure value including any adjustment.

All settings remain unchanged until they are erased and the system unlocked by depressing the AE-lock button or by removing the battery.

A Automatic Mode

Function:

Automatic exposure with aperture priority, pre-selected film speed and automatically calculated shutter speed.

Features:

Continuous metering of the light value. Locking and storing of the light value at a selected moment by keeping the exposure button at the pressure point. Permanent adjustment of the continuous or stored light value ± 5 EV-steps in 1/3 step increments.

The Automatic Mode A differs from the Automatic Bracketing Mode Ab (page 44) by disabling the bracketing facility and making light value readings at each single exposure. Thus, in a sequence, the shutter speed may change from one exposure to the next, despite the fact that the exposure button is kept depressed during the sequence. The viewfinder display is identical to the Ab mode.

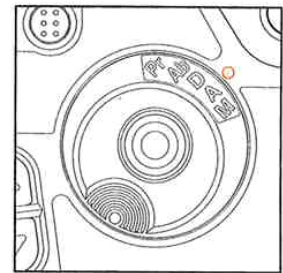

Operating Modes, Automatic Mode 51

- Depress the exposure release or the pre-release button to the pressure point. The metering system starts and the viewfinder display shows the symbol "M" for Manual Mode and the pre-set aperture and shutter speed.

- Release the exposure button. Instead of the aperture value the display starts showing the difference in EV-steps between the set exposure and the calculated "normal" exposure for the present subject part with an accuracy of 1/3 EV-step, continuously changing the indication as the metering area is moved about the subject.

- The normal function of the adjustment buttons is disabled in the "M" mode. To change the exposure values, e.g. to adjust the exposure to 0 difference for a certain subject area, change the aperture or the shutter setting (or both) until the difference indication on the display reads within $0 \pm 1/3$.

- Depress the exposure release button for an exposure with the set values, independent of the meter readings.

- Rewind the camera to cock the shutter and advance the film for the next frame. All settings remain until you change them manually.

NOTE: The metering system could be started by depressing the AE-lock button as well. In that case the display starts by showing the difference as per p.5 above.

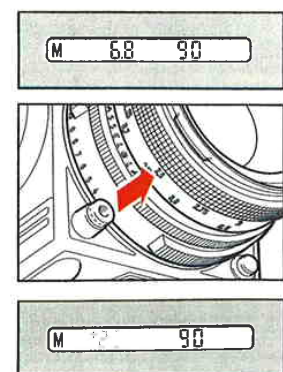

Operating Modes, Manual Mode 53

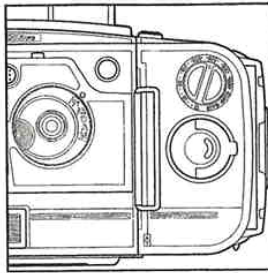

M (ref) Manual Mode, reference
Normal exposure, reference function on.

Functions:
Manual pre-setting of aperture as well as shutter speed.
Pre-programming of acceptable exposure variation and optional warning function.

Features:
Fully manually controlled exposure.
Continuous metering of the light value.
Continuous indication of the difference in EV between the determined, set, and stored exposure and the presently required one.
Warning indication when the ambient conditions require an exposure outside the pre-programmed acceptable variation.

How to Use the "M (ref)" Mode

The M(ref) Mode is completely manual, but the metering system is still working. It detects any change in the ambient conditions but does not change the shutter speed (the aperture is always pre-set manually). You decide the proper exposure for the actual subject yourself, using the camera's metering system or any other means, and enter that exposure manually by setting the aperture and shutter speed.
That exposure is then stored in the metering system as your **reference level**, indicated as 0 (zero) on the display (p. 6 below). Any deviation from that reference level is then indicated in EV on the display, but the exposure will be executed according to the settings you have made manually.

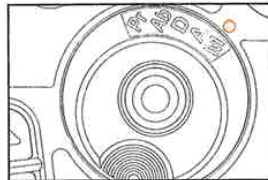
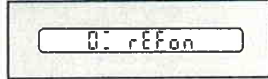

54 Operating Modes, Manual Mode (ref)

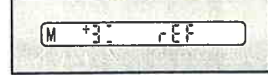
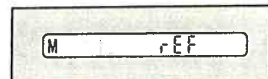

7. Release the AE-lock. When conditions, e.g. lighting or camera settings change, the display continuously shows the difference in EV to the reference level. If an exposure variation range has been set, the display starts flashing when the difference is outside that range.

8. Depress the exposure release button to the pressure point. The display changes to the same state as in p.4 above.

9. Depress the exposure release button for an exposure with the pre-set values, independent of the meter readings.

10. Rewind the camera to cock the shutter and advance the film for the next frame. All settings remain until they are changed manually.

NOTE: The metering system could be started by depressing the AE-lock button as well. In that case the system starts as described in p.6 above.

M (L.E.) Manual Mode

Long exposure, metering system disabled.

Functions:
Manual pre-setting of aperture as well as shutter speed.

Features:
Completely manually controlled exposure.
Shutter speeds from 1 second thru 34 minutes (see page 22).
Indication of aperture and shutter speed.

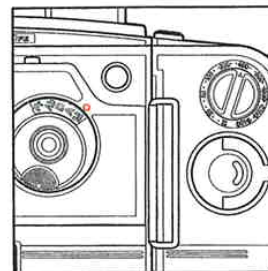

56 Operating Modes, Manual Mode (L.E.)



Warning Functions

Whenever the camera settings could result in an exposure error the red warning triangle flashes.

Permanent Warnings

The permanent warning functions are built into the system and cannot be changed or disabled.

Battery Capacity Warning

When the battery voltage drops below a certain point, the battery symbol is displayed for at least two seconds and the warning triangle flashes twice.

NOTE: Battery recovery may cause the battery symbol to disappear after the two seconds.

Shutter Speed Warning

When the calculated shutter speed is slower than 90 s or faster than 1/2000 s the shutter speed indication and the red warning triangle start flashing.

Light Meter Range Warning

When the light value falls below or above the range of the light meter the indication "Lo" or "Hi" resp. appears in the left hand part of the display. If no other light value is stored the warning triangle flashes.

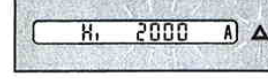
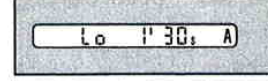
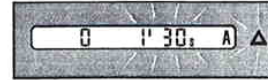

58 Warning Functions, Permanent Warnings

Suggested procedure:

1. Pre-set the film speed with the film speed dial on the E- (or TOC-) magazine or using the Pr mode with a standard magazine. Also use Pr mode to switch on the reference function and set the acceptable exposure variation range.
2. Set the Mode Selector Dial at M.
3. Determine the appropriate exposure. Set the aperture and shutter speed accordingly, or use the procedure described in p.6 on page 53.
4. Depress the exposure release or the pre-release button to the pressure point to start the metering system. The viewfinder display shows the symbol "M" for Manual Mode, the difference in EV between the pre-set and the calculated exposures for the present subject part with an accuracy of 1/3 EV-step, continuously changing the indication as the metering area is moved about the subject, and the shutter speed setting.
5. Release the button. The display now continuously shows the difference in EV to any previously stored value, and the sign "ref".
6. Press the AE-lock to store the pre-set exposure value as your **reference level**. The display now shows 0 for "no difference", and the sign "ref".

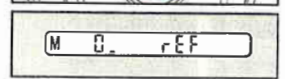
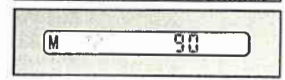
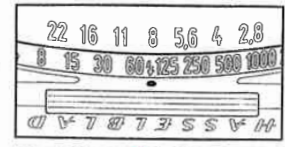

Operating Modes, Manual Mode (ref) 55

How to Use the "M (L.E.)" Mode

The M (L.E.) mode is completely manual. The metering system is disabled. The display indicates the manual settings.

Suggested procedure:

1. Set the Mode Selector Dial at M.
2. Depress the exposure release button or the AE-lock button to start the camera
3. Depress both adjustment buttons at the same time to select "long exposure"
4. Determine the appropriate exposure and set the aperture and the shutter speed manually. The display shows the letters "M" and "L.E." to indicate the long exposure function and the selected shutter speed in minutes and seconds.
5. Depress the exposure release or the pre-release button to the pressure point. The display changes to show the pre-set aperture and shutter speed.
6. Depress the exposure release button all the way in for an exposure with the set values.
7. Rewind the camera to cock the shutter and advance the film for the next frame. All settings remain until you change them manually. The long exposure function remains active until 4 seconds after the camera auto switch-off.

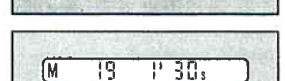
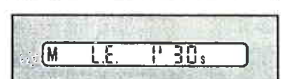
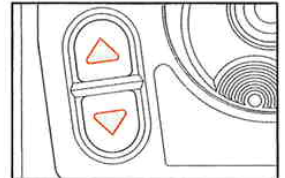

Operating Modes, Manual Mode (L.E.) 57

Flash Photography Warnings

In dedicated flash photography the indication "Hi FLASH" or "Lo FLASH" is displayed together with the flashing warning triangle and display backlighting if the flash was too bright or if it was insufficient. This warning is on for 2 seconds after the exposure.

If the pre-set film speed exceeds the range for the automatic flash control (ISO 25 - 1000) the indication "FLASH Er" is displayed when the exposure button is depressed to the pressure point

Reference Warning

The difference indication flashes when the pre-set limit is exceeded.
This optional warning function can be set, changed or disabled by you (Pr5, page 44).

Flash Photography Dedicated Flash Unit

The flash control function in the 203FE works behind the selected mode of operation, which basically remains unchanged. The film speed range for the flash function is ISO 25 - 1000. When a dedicated flash unit, such as the Hasselblad Profiflash 4504, or another unit complying with the European SCA-standards is connected to the dedicated flash socket (page 14) - directly or through a suitable adapter - and switched on, the green flash symbol in the viewfinder automatically lights up when the flash is charged and operative. If a plus or minus flash metering adjustment has been entered, the +, - or +/- sign also appears in the display.

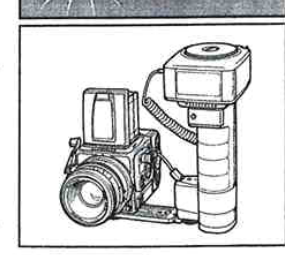
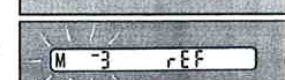
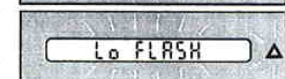

Flash Photography, Dedicated Flash 59

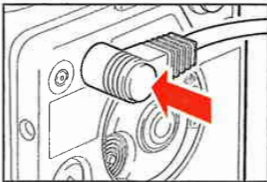
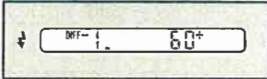
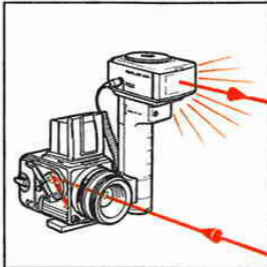

60 Flash Photography, Dedicated Flash

Your 203FE controls the flash duration by TTL/OTF metering (TTL = Through The Lens; OTF = Off The Film), i.e. it meters the light reflected off the film and terminates the flash when the exposure is correct.

There is of course also the possibility to connect the flash unit to the PC socket, but then you no longer have the advantage of letting the camera system control the flash and the exposure.

The camera continues to operate in the selected mode with the calculated or pre-set shutter speed.

If an automatic mode is desired for the camera the D mode is recommended. Meter the selected subject area, lock the metered value and make the desired adjustments. Then adjust the aperture or use the adjustment keys **until the shutter speed figure stops flashing** to be sure that the shutter speed will be slower than 1/90 s. Note that even the displayed 1/90 s could be flashing!

NOTE: If the shutter speed is faster than 1/90 s the shutter speed display flashes and no sync signal is generated to trigger the flash.

How to Use the Dedicated Flash
A. Flash set at TTL Mode

For the operation of the flash unit see the flash unit Instruction Manual.

Functions:

- Fully automatic exposure control through TTL/OTF metering.
- Exposure with pre-set aperture and shutter speeds slower than 1/90 s.

- Pre-set flash exposure adjustment -3 to +1 EV through Pr mode (page 42) indicated by the r.h. minus alt. plus sign.
- Display warning when the pre-set or calculated shutter speed is faster than 1/90 s.
- Display warning when the pre-set film speed is outside the range (ISO 25-1000)
- Viewfinder indications when the flash unit is charged and ready to flash.
- Viewfinder warning at over- and underexposure or disabled flash triggering.

Suggested procedure:

1. Attach and connect the flash according to the Flash Manual. With the Hasselblad Profiflash 4504 connect the Hasselblad TTL-cable between the dedicated flash socket in the camera body (page 29) and the TTL socket in the flash unit. (The PC connector of the Profiflash 4504 is inoperative but can be "parked" in the PC-socket.)
2. Set the flash unit at TTL or corresponding mode and switch it on. Start the camera. When the flash unit is charged and ready to flash the green flash symbol (see page 18) lights up in the viewfinder. If a flash power adjustment has been entered, also the r.h. plus/minus sign appears in the display.
3. In manual mode, pre-set the aperture and set the shutter speed not to exceed 1/90 s. In automatic mode follow the recommended procedure on page 60!

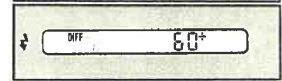
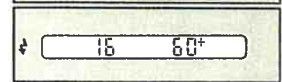
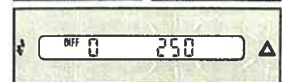
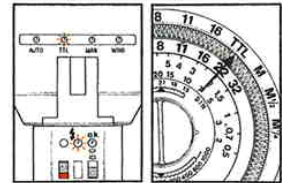
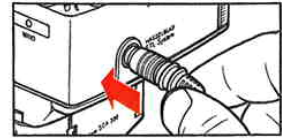

Flash Photography, Dedicated Flash 61

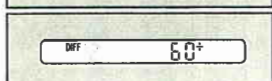
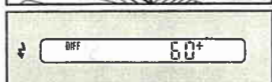
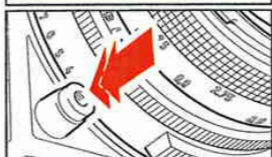
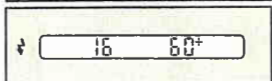
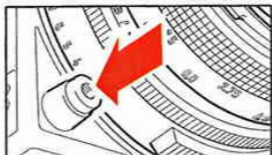

62 Flash Photography, Dedicated Flash

4. Depress the exposure button to the pressure point. The camera is working in the selected mode. When the exposure button is depressed to the pressure point the display appearance is according to that mode except for the described flash indications.

5. Depress the exposure button fully to make the exposure and trigger the flash. The control circuits in the camera cut the flash when the exposure is correct.

Release the exposure button. If the flash was powerful enough to produce a correct exposure but did not use up all the power the flash symbol stays on and the display returns to its normal appearance.

Did it use up most of the power the flash symbol turns off while the flash unit is recharging and lights up again when it is fully recharged.

WARNINGS (page 58):

The sign "Hi FLASH" appears on the display when the flash was **too bright**, e.g. if the flash-to-subject distance is short, the camera aperture large, the film fast or any combination of these. The remedies are to move the flash away from the subject (use a lens with longer focal length), reduce the aperture, change to a slower film.

The sign "Lo FLASH" appears when the flash was **insufficient** to give a correct exposure, e.g. if the flash-to-subject distance is too long, the aperture is too small, the film too slow. The remedies are shorter flash-to-subject distance, larger aperture or faster film. It also appears at shutter speed faster than 1/90 s when the flash triggering was disabled when the exposure was released.

In both cases the suggested remedies could be combined in any desired way. Both warnings appear for two seconds after the flash exposure together with a flashing display backlighting, which also is visible from the outside in the display backlighting window.

6. Rewind the camera to cock the shutter and advance the film to the next frame.

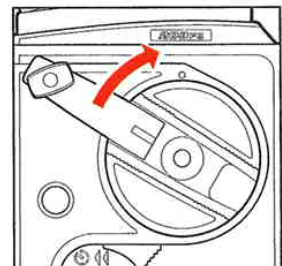

Flash Photography, Dedicated Flash 63

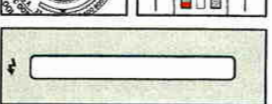
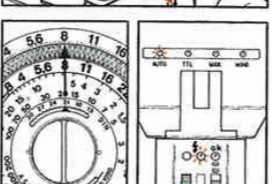
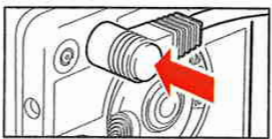

64 Flash Photography, Dedicated Flash

B. Flash set at Automatic Mode

The flash unit should be set for its own built-in automatic control (see the flash unit instructions).

Functions:

- Automatic exposure control through the built-in system in the flash unit.
- Exposure with pre-set aperture and shutter speed determined by the selected operating mode.
- Viewfinder indication when the flash unit is charged and ready to flash.
- Viewfinder warning at over- and underexposure and disabled flash triggering.

Suggested procedure:

1. Attach and connect the flash according to the Flash Manual. With the Hasselblad Profiflash 4504, connect the TTL-cable between the dedicated flash socket in the camera body (page 29) and the TTL socket in the flash unit. (The PC connector of Profiflash 4504 is inoperative but can be "parked" in the PC-socket.)

2. Set the flash unit to Automatic or corresponding mode, set the film speed on the flash unit's dial and switch it on. When the flash unit is charged and ready to flash, the green flash symbol (page 18) lights up in the viewfinder.

3. Select and pre-set the lens aperture for the desired depth-of-field and set the flash dial at the corresponding aperture value

or

set the flash-to-subject distance on the flash dial, read the corresponding aperture value on that dial and pre-set the camera aperture at the same value.

4. Depress the exposure release or the pre-release button to the pressure point to start the camera. The camera operates in the selected mode and the display shows the corresponding indications.

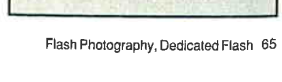
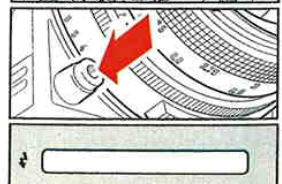
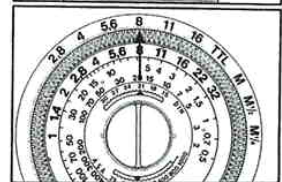
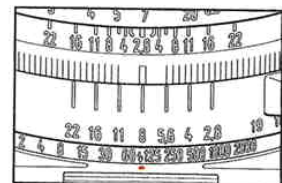

Flash Photography, Dedicated Flash 65

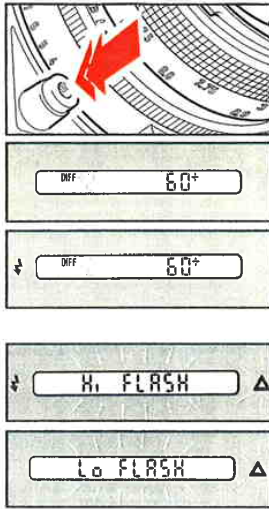

- Depress the exposure release button fully to make the exposure and trigger the flash. The control circuits in the flash unit cut the flash when the exposure is correct. If the flash was powerful enough to produce a correct exposure and did not use up all the energy the flash symbol stays on. Did it use up most of the energy the flash symbol turns off while the flash unit is recharging and lights up again when it is fully recharged.

WARNINGS (page 58):

The sign "HI FLASH" appears on the display when the flash was **too bright**, e.g. if the flash-to-subject distance is short, the camera aperture large, the film fast or any combination of these. The remedies are to move the flash away from the subject (use a lens with longer focal length), reduce the aperture, change to a slower film. The sign "Lo FLASH" appears when the flash was **insufficient** to give a correct exposure, e.g. if the flash-to-subject distance is too long, the aperture is too small, the film too slow. The remedies are shorter flash-to-subject distance, larger aperture or faster film. It also appears at shutter speeds faster than 1/90 s when the flash triggering was disabled. Both warnings appear together with a flashing display backlighting for two seconds after the flash exposure.

- Rewind the camera to cock the shutter and advance the film to the next frame.

66 Flash Photography, Dedicated Flash

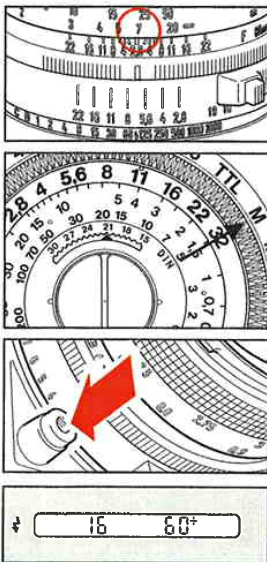

- Estimate the flash-to-subject distance or measure it by focusing the lens and reading the distance from the focusing scale.

- Determine the aperture setting using the aperture calculator on the flash unit or the Guide Number (see the flash unit manual).

- Depress the exposure release or the pre-release button to the pressure point to start the camera. The display indicates the aperture setting and the shutter speed. Is the Mode Selector Dial set at **Ab**, **A** or **M** the symbols **A** or **M** are also shown but other symbols are not.

68 Flash Photography, Dedicated Flash

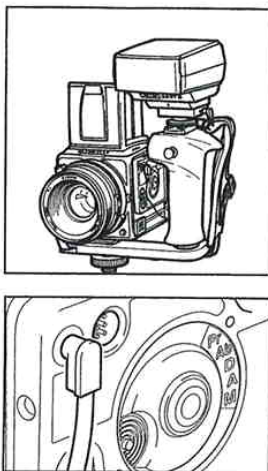

Non-dedicated Flash Units

With a non-dedicated flash unit you can not take advantage of the sophisticated TTL/OTF flash metering and control system in the 203FE and the viewfinder information supplied by this system. You then have to rely on the control system of the flash itself or your own aperture calculations. Always refer to the Flash Instruction Manual for flash settings and Guide Number!

The non-dedicated flash unit should be connected to the PC-socket next to the TTL socket on the left hand side of the camera body through a conventional synchronization cord, usually supplied with the flash unit. The metering system and the viewfinder display in the camera will work normally in all operating modes as if no flash was connected, i.e. the flash symbol in the viewfinder will not light up when the flash is ready.

NOTE: The fastest shutter speed for full flash synchronization is 1/90 s corresponding to the flash symbol on the shutter speed ring. At faster speeds the PC-terminal is disconnected and the flash is not triggered. Use the camera's **M** mode and the 1/90 s shutter speed to ensure that the flash will fire. Since the metering system automatically calculates and sets the correct shutter speed in the modes **Ab**, **A** and **D** you must monitor the viewfinder display closely to check that the shutter speed is 1/90 s or slower before making the exposure. Change the pre-set aperture or use the adjustment buttons to change the shutter speed if necessary.

70 Flash Photography, Non-dedicated Flash

C. Flash set at Manual Mode

The flash unit should be set for manual control (see the flash unit instructions).

Functions:

Exposure with pre-set aperture and shutter speed determined by the operating mode.
Viewfinder indication when the flash unit is charged and ready to flash.
Viewfinder warning at over- and under-exposure and disabled flash triggering.

Suggested procedure:

- Attach and connect the flash according to the Flash Manual.
With the Hasselblad Prof flash 4504 connect the TTL-cable between the dedicated flash socket on the camera body (page 29) and the TTL socket on the flash unit.
(The PC connector of Prof flash 4504 is inoperative but can be "parked" in the PC-socket.)
- Set the flash unit to Manual or corresponding mode and switch it on. When the flash unit is charged and ready to flash, the green flash symbol (page 18) lights up in the viewfinder.

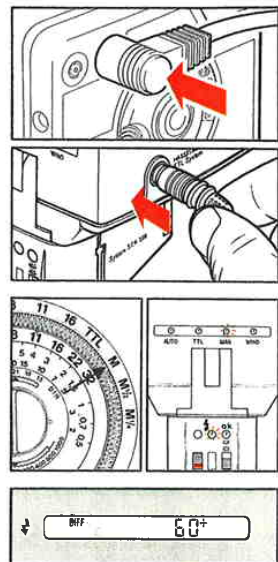

Flash Photography, Dedicated Flash 67

- Depress the exposure release button fully to release the exposure and trigger the flash. In Manual mode the flash normally uses full power.

The flash symbol turns off while the flash unit is recharging and lights up again when it is fully recharged.

WARNINGS (page 58):

The sign "HI FLASH" appears on the display when the flash was **too bright**, e.g. if the flash-to-subject distance is shorter than estimated or the subject brighter than normal. The remedy is to reduce the aperture.

The sign "Lo FLASH" appears when the flash was **insufficient** to give a correct exposure, e.g. if the flash-to-subject distance is longer than estimated or the subject darker than normal. The remedy is to use a larger aperture. It also appears at shutter speed faster than 1/90 s when the flash triggering was disabled. Both warnings appear together with a flashing display backlighting for two seconds after the flash exposure.

- Rewind the camera to cock the shutter and advance the film to the next frame.

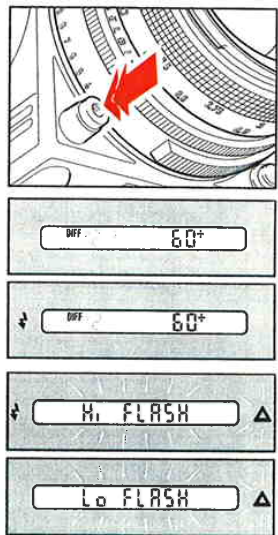

Flash Photography, Dedicated Flash 69

How to use a Non-dedicated Flash Unit

Suggested procedure:

- Connect the flash to the PC-socket on the camera body and switch it on.
- Pre-set the desired aperture.
- Use the camera as described in any desired operating mode, observing the shutter in the modes **Ab**, **A** and **D**. Pre-set the shutter speed 1/90 s (flash symbol) in **M** mode.

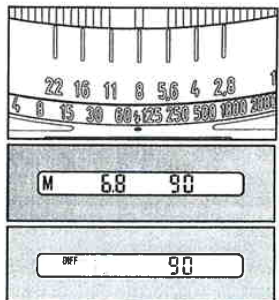

203FE with other Hasselblad Lenses

You can use the Hasselblad F-, CF- and C-lenses on your 203FE without fear of damaging camera or lens. Since these lenses do not have the electronics required by the metering system, there will be a few minor limitations in the camera functions. In this section you will find information on the F-lenses and how to use them on your 203FE. How to use the CF- and C-lenses is described in Appendix A, page 83.

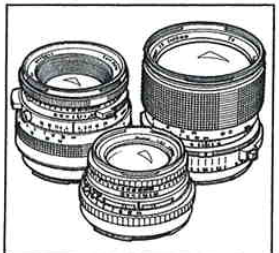

Flash Photography, Non-dedicated Flash 71

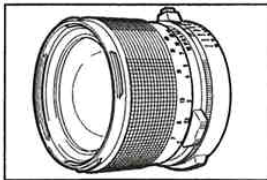

F-lenses

The F-lenses are optically, mechanically and operationally identical with the corresponding FE-lenses but are not equipped with their internal electronics and external identifications. The instructions for the FE-lenses are generally applicable also to the F-lenses (page 31).

NOTE: With an F-lens on the camera the aperture value does not appear in the viewfinder display when the exposure or pre-release button is depressed. Instead the display shows two dashes (--).

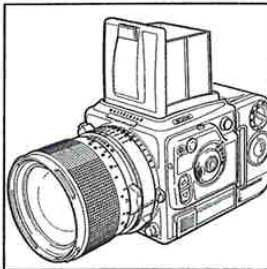
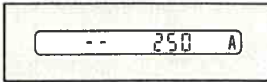

How to use the 203FE with an F-lens

Like all Hasselblad lenses the F-lenses are normally opened up to the largest aperture in viewing position but can be stopped down manually to the pre-set aperture. Since no information on the pre-set aperture is transferred to the metering system in the camera body the shutter speed calculated by the system relates to the actual lens aperture. To get a correctly calculated shutter speed you have to stop down the lens to the pre-set aperture before you make the exposure. With the extra-ordinary brightness of the Acute-Matte focusing screen there are usually no difficulties to focus with a stopped-down lens.

Suggested procedure:

1. Pre-set the film speed as previously described.
2. Pre-set the desired aperture value.
3. Set the Mode Selector Dial at the desired mode of operation.
4. Stop down the lens by pushing the pre-view knob down until it locks (page 32).
5. Follow the instructions for the selected mode of operation.

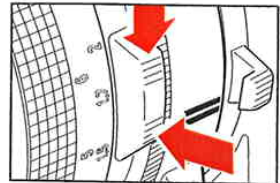
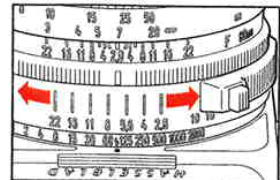

Flash photography with F-lenses

The overall similarity between the FE- and F-lenses makes the flash photography procedures almost identical. The only difference is that the aperture value does not appear on the viewfinder display.
Dedicated Flash Unit
The TTL/OTF flash control system makes no difference between the FE- and F-lenses as it always operates when the lens is stopped down during the exposure.

How to use the Dedicated Flash

The procedures are identical to those described for the FE-lenses in all flash and camera modes of operation (pages 56-63).
Non-dedicated Flash Unit
The information and procedure described for the use of a non-dedicated flash unit together with a FE-lens (page 66) is in all parts applicable with an F-lens.

Accessories

All accessories originally designed for the 203FE are marked with the blue twin lines. The mark is always located on that side which is to the left when the accessory is attached to the camera to make it easily identified.

Other accessories are so called "general accessories". These accessories do not have the blue twin lines but can still be used on the 203FE without restrictions.

A third group of accessories can be used but will cause certain limitations to the TCC functions.

Finally there is a fourth group of accessories that cannot in any way be used on the 203FE.

Accessory Mounts

The quick coupling plate on the bottom of the camera body (pages 25 and 72) fits to the handy and reliable Hasselblad tripod quick coupling and to the flash gun bracket. On the front of the lenses are external and internal bayonet mounts for filters, close-up lenses and lens shades. The viewfinder mount on top of the camera body accepts various focusing screens and viewfinders. Underneath the winding crank is a bayonet mount for the Hasselblad Winder.

Major FE Accessories

A selection of the most important FE accessories is described below. For a complete review of the Hasselblad system refer to the Hasselblad Product Catalog.

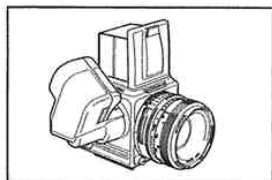

Winder

The TCC Winder motorizes the 203FE for a maximum frame rate of 1,3 fps.

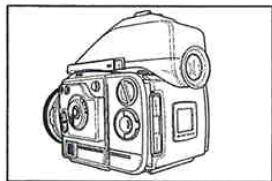

Viewfinders

Besides the focusing hood which is delivered with the camera body you have a choice of a magnifying hood and prism viewfinders with and without exposure meters.

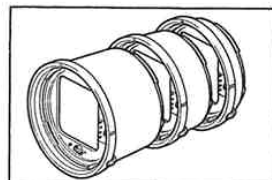

E-type Extension Tubes

For close-up and macro photography the E-type extension tubes have all connections, both mechanical and electrical, between camera body and lens.

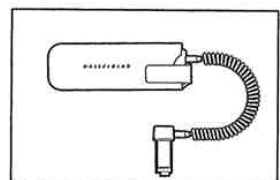

External Battery Cassette

The external battery cassette connector replaces the original battery cassette in the battery compartment. It provides additional power and the extension cord allows you to keep the batteries warm in your pocket when you are using the 203FE in cold conditions.

General Accessories

The range of general Hasselblad accessories that can be used on the 203FE without affecting the metering functions includes different focusing screens, lens shades and filter adapters. There is also the Hasselblad Winder and the Hasselblad Profiflash 4504 dedicated flash unit. Other dedicated flash units can be connected through flash adapters, such as the Hasselblad SCA 390 and SCA 590.

Other Accessories

These accessories can be used but will result in certain limitations to the metering system. The F and CF lenses belong to this group, as

do the bellows and the PC-Mutar. Also some of the discontinued accessories such as the C lenses belong here.

Finally there is a group of accessories which cannot be used on your 203FE, such as the other viewfinders, the grips and the accessories designed to be attached to the accessory rail on the other Hasselblad reflex models.

The Hasselblad System Chart

Overleaf you will find the accessory chart that indicates the different groups of accessories in the Hasselblad System. Refer to the Hasselblad Product Catalog for complete information on the entire Hasselblad System.

Hasselblad System Chart

FE and Accessories
Most E and TCC accessories fit on the other Hasselblad SLR models.

General Accessories
Can be used on the 203FE without affecting the metering function

Other Accessories
Cause limitations to the metering function when used on the 203FE

Troubleshooting

Your Hasselblad 203FE is built for long and trouble-free service, especially when you follow the advices on maintenance and care (page 82). Should you encounter any operational difficulties the troubleshooting chart below may help you to resolve them.

PROBLEM	POSSIBLE CAUSE	REMEDY
The camera can not be activated in any way.	The battery is removed or completely exhausted. The battery is reversed. The camera was not rewound after the last exposure.	Install or replace the battery. Insert the battery according to the labeling on the battery cassette. Wind the camera with one full turn of the winding crank.
The camera cannot be activated by depressing the AE lock.	The AE lock has been depressed for more than 16 seconds.	Activate the camera by depressing the exposure release button.
The exposure release button cannot be depressed.	The camera was not rewound after the last exposure. The magazine slide is in the magazine. The roll of film is finished (frame counter at end).	Rewind the camera with one full turn of the winding crank. Remove the magazine slide completely. Insert a new film or change to a fully loaded magazine (or w/o film remove and re-insert film holder).
The viewfinder image is dark but the display is bright.	The lens front cover is on.	Remove the lens front cover.

78 Troubleshooting

PROBLEM	POSSIBLE CAUSE	REMEDY
The viewfinder image is dark but the display is bright.	The camera is pre-released. The camera has a C lens or a CF lens in C setting attached and was not rewound after the last exposure.	Complete the camera release or depress the double exposure button and wind the camera with one full turn of the winding crank. Rewind the camera with one full turn of the winding crank.
The lens cannot be attached.	The lens is released. The camera body is pre-released or released.	Cock the lens. Release and/or rewind the camera with one full turn of the winding crank.
The lens cannot be detached.	The camera is pre-released or released.	Release and/or rewind the camera with one full turn of the winding crank.
The magazine cannot be detached.	The magazine slide is not completely inserted.	Push the magazine slide in until it positively stops.
The flash symbol does not light up when a dedicated flash unit is connected.	The flash unit is not switched on or is not fully charged and ready to be fired. The connection between flash unit and camera is defective.	Switch on the flash unit and/or wait until it is fully charged. Check the connections according to the flash unit's manual. Replace the TTL sync cord.

Troubleshooting 79

Faulty and Error Indications on the Viewfinder Display (All parts have system mark)

PROBLEM	POSSIBLE CAUSE	REMEDY
The display signs appear reversed.	The viewfinder is not properly installed.	Push the viewfinder firmly forwards until it stops.
Aperture indication is "-- --"	Defective contact between lens and camera body.	Detach the lens. Clean all four contact surfaces on the lens and on the camera body with a lint-free cloth or suede. DO NOT touch the contact surfaces with your fingers!
The magazine symbol appears when a TCC magazine is attached.	Defective contact between magazine and camera body.	Detach the magazine. Clean all four contact surfaces on the magazine and on the camera body with a lint-free cloth or suede. DO NOT touch the contact surfaces with your fingers!
The display indicates "Err 1", "Err 2" or "Err 12 4", possibly together with A or M.	Electronic system error.	Bring the camera to an authorized "Hasselblad Service Center". Explain the look of the display to the service technician.

NOTE: If there is a contact failure between the lens and the camera body you can still use your equipment according to the instruction for the F lens (page 72-73). Contact failure between the magazine and the camera body could be overrun by selecting Pr mode and entering the film speed manually (page 41).

80 Troubleshooting

Technical Specifications and Equipment, 203FE

Camera Design: Medium format single lens reflex camera with built-in TTL selective meter electronically connected to FE lenses and E magazines. Interchangeable lenses, film magazines, viewfinders and focusing screens.

Shutter: Electronically controlled mechanical focal plane shutter with release solenoid system. Horizontally running textile curtains. Shutter speed range B, 90 s - 1/2000 s; in Manual Mode up to 34 minutes. Fully mechanical C setting for lenses with built-in leaf shutters. Flash synchronization from B up to 1/90s.

Lens Mount: Hasselblad bayonet mount for FE, F, CF and C lenses. Contacts for data-bus communication with the FE lenses.

Viewfinder: Focusing hood with 4 x magnifier, interchangeable with magnifying hood and prism viewfinders with and without exposure meter. TCC viewfinders only acceptable. Acute-Matte focusing screen interchangeable with other Hasselblad focusing screens. Illuminated flash and warning symbols.

Operation Display: LCD display in viewfinder with all relevant exposure and operational data and switch-controlled low light illumination.

Camera Winding & Film Advance: Manual single turn winding crank. Simultaneous shutter cocking and film advance. The crank is interchangeable with the Hasselblad motor winder for up to 1.3 frames/second.

Exposure Meter: TTL metering at full aperture with FE lenses. High sensitivity silicon photocell. Selective meter area approximately 20% of the image area. Metering range EV 0.5 to EV 21.5 at ISO 100/21° and f/2.8. Active time 16 s after release of any operational button.

more >

Technical Specifications 81

Exposure Functions:	Aperture priority automatic exposure, automatic flash control and full manual control. Exposure compensation ± 5 EV in 1/3 EV increments. AE-lock.
Operating Modes:	Programming Mode, Automatic Bracketing Mode, Differential Mode, Automatic Mode and Manual Mode.
Film Speed Range:	ISO 12/12° to ISO 6400/39°, selected with film speed dial on E and TCC magazines or entered in programming mode.
Flash Control:	Center weighted TTL/OTF flash exposure meter. Full dedicated flash control with inhibited flash triggering at shutter speed faster than 1/90 s. Flash control film speed range ISO 25 - 1000.
Selftimer:	Default delay 10 s. Delay programmable in 12 steps from 2 s to 60 s.
Battery:	6V, type PX28L, 4G-13 or equivalent lithium type.
Tripod Mount:	Quick coupling plate and 1/4" socket thread.
External Dimensions:	Camera body only see page 81. With focusing hood, lens Planar FE 2,8/80 and magazine E 12: 185L x 117W x 110H mm (7 9/32 x 4 5/8 x 4 11/32 in.)
Weight:	1660 g with focusing hood, lens Planar FE 2,8/80, E12 magazine and battery. Body alone: 745 g.

The camera body (chrome finish P/N 10561, black finish P/N 10574), comes with focusing hood, focusing screen, winding crank, shoulder strap, front and rear protective covers.

For comprehensive information on accessories please refer to the Hasselblad Product Catalog.

Camera Body Dimensions

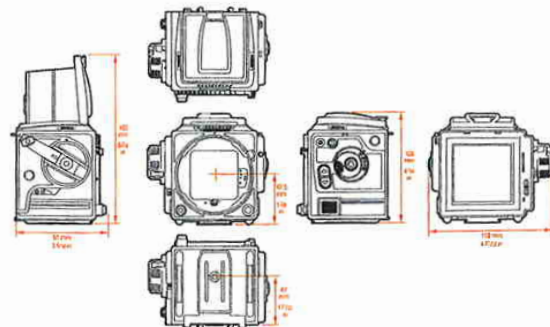

Hasselblad reserve the right to change the specifications without prior notice.

Hasselblad 203FE is covered by several Swedish and foreign patents.

82 Technical Specifications

Dimensions 83

Camera Care, Service and Guarantee

Camera Care.

Your Hasselblad camera is designed to withstand the rigours of professional use in most environments. In order to avoid the possibility of damage, however, the camera should be protected from the following.

Extremes of temperature. High temperatures can have an adverse effect on both the film and the camera. Do not keep your camera in places where it may get hot, such as in direct sunlight or above a radiator. In tropical environments fungus growth can be prevented by keeping your equipment in an area where the air is circulating. Frequent rapid and severe temperature changes can cause problems such as corrosion of electrical contacts, and should be avoided. When in extremely cold temperatures, cameras and especially lenses should be protected as much as possible.

Dust and grit. Prevent dirt of any kind from getting into your camera. When taking photographs in coastal areas for example, the camera should be protected from sand and salt water spray.

You can blow away dust on the lens glass, magnifier of focusing screen, or wipe it off gently with a soft cloth if necessary. Smears on the lens glass should be removed with a high quality lens cleaning solution on a soft, clean tissue. Be careful not to scratch the lens or touch any of the glass surfaces with your fingers. The surface of the mirror

is coated and should be blown clean but not be wiped. Lens cleaning solvents or other chemicals should not be used on the focusing screen.

Impact. Your camera can be damaged by severe physical shocks. You should take care not to leave it where it can fall or be knocked to the ground, or roll about.

Service. Faultless camera performance is essential to the professional photographer. Therefore it is advisable to check that your camera is functioning correctly before an important assignment. You should also return your camera to a "Hasselblad Authorized Service Center" for periodical checking and preventive maintenance. If your camera is used constantly and intensively, exposing hundreds of rolls of film per week, checkups every six months are recommended. Hasselblad Service Centers have the expert staff and specialized equipment necessary to ensure that your camera remains in perfect working order.

Guarantee. Provided that you bought your camera from an authorized Hasselblad outlet, it is covered by an international guarantee for one year. The guarantee document and a registration card are supplied with the camera. Keep the guarantee document carefully, but fill in the registration card and return it to your Hasselblad distributor.

APPENDIX A

Hasselblad 203FE with CF- and C-lenses

The CF- and the older C-lenses differ from the FE- and F-lenses through their built-in leaf shutter with shutter speeds from 1 to 1/500 s and B. Both types have flash synchronization on all shutter speeds. The CF-lenses also have an additional shutter setting F to let the lens be used together with the focal plane shutter and the instant return mirror

NOTE: Avoid using the 203FE with a C-lens in temperature conditions below 0°C (32°F).

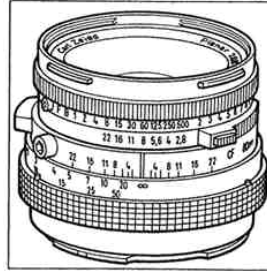

CF-lenses

With a CF-lens on your 203FE you can choose to use the focal plane shutter with all its advantages and full automation or to disengage the focal plane shutter and benefit from the advantages of lens' built-in leaf shutter with battery independence and a wider choice of flash synchronization on faster shutter speeds.

NOTE: When you need shutter speeds of 1/250 s or faster while using a CF-lens, you are under certain conditions recommended to set the lens shutter at F (see page 84) and use the camera's focal plane shutter

CF-lens design and functions

The setting rings and scales on the CF-lenses are arranged differently from those on the F-lenses. Counted from the camera body and towards the rings are:

- Focusing ring with focusing distance scale in feet (orange) and meters (white).
- Common index line and depth-of-field scale.
- Aperture ring with aperture scale and EV index (orange).
- Shutter speed ring with shutter speed scale, EV scale (orange) and F lock button (green).

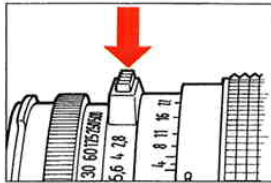

EV Interlock Button

Depressing the EV interlock button interlocks the shutter speed and aperture rings to make it possible to change the combined speed/aperture setting without changing the EV.

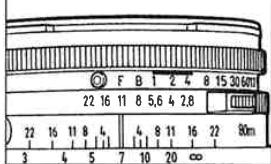

Depth-of-field Preview Knob

The Depth-of-field Preview knob location and operation is identical to the FE- and F-lenses (page 32).

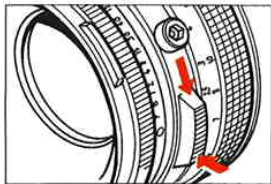

F-setting

Depress the small green F-lock button to the left of the green F on the shutter speed ring. Keep it depressed while turning the ring to align the F with the index line. Release the button to lock the ring in the F position. The F setting locks the shutter wide open without interfering with the aperture function. With this setting the lens works exactly as an F-lens (page 69).

How to use the CF-lens

A. Lens in F mode (leaf shutter open)

Suggested procedure:

1. Turn the shutter speed ring to the F setting.
2. Operate the camera as described for the F-lens

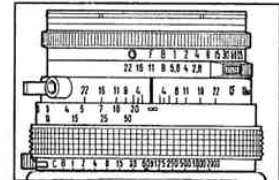

B. Lens in C mode (leaf shutter working)

When using the built-in leaf shutter in the CF-lens the focal plane shutter in the camera body must be disengaged. By setting the camera's shutter speed ring in the C position (page 22, 23) the focal plane shutter is turned into an auxiliary shutter, only used to protect the film from inadvertent exposure.

NOTE: The leaf shutter remains closed after the exposure, leaving the viewfinder screen dark until the camera is rewound.

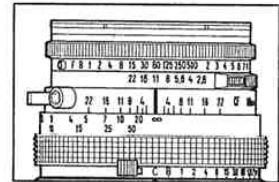

Suggested procedure:

1. Check that the lens' shutter speed ring is not set at F.
2. Keep the lens catch button depressed while turning the camera's shutter speed ring to align the C at the end of the scale with the red index mark.
3. Release the lens catch button to lock the shutter speed ring in the C setting.

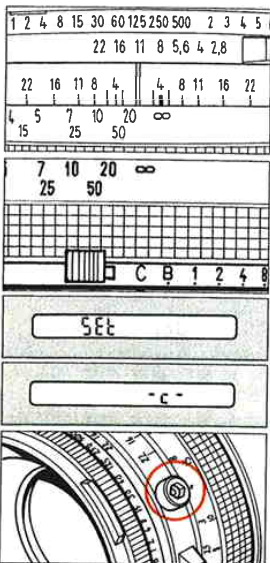
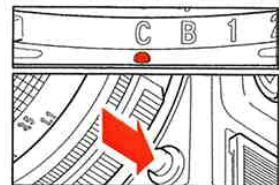

4. Pre-set the desired aperture and shutter speed on the lens scales.
5. Press the exposure button to make an exposure with the pre-set values.
6. Rewind the camera to get the viewfinder image back, advance the film to the next frame and to cock the lens shutter.

NOTE: If the selected camera mode is Ab, D or A the display indicates the proper shutter speed to be set on the lens' shutter, provided that the lens has been stopped down manually to the preselected f-stop. In the M mode, setting the camera's shutter speed ring at C turns off the entire metering system. The viewfinder display shows only (-c-) for the shutter speed when the exposure or pre-release button is depressed. The AE-lock button is inoperative.

Flash photography with CF-lens

The CF-lenses have a built-in X-type flash synchronization at all shutter speeds. Flash connection is the PC socket located on the left hand side of the lens, close to the depth-of-field scale.

Lens in F mode

Dedicated and non-dedicated Flash Units

The procedures are identical to the corresponding procedures for the F-lens (page 71).

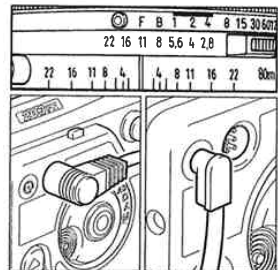

Lens in C mode

Dedicated Flash Unit

Although the metering system is turned off in C mode the TTL/OTF system is still working to control the dedicated flash unit directly - as with the Hasselblad Proflash 4504 - or through an suitable adapter. However, since the focal plane shutter is not working as a shutter the triggering of the flash must come from the shutter in the CF-lens. The green "ready" flash symbol works and the "HI FLASH" and "Lo FLASH" warning indications may appear in the viewfinder when the exposure button is released.

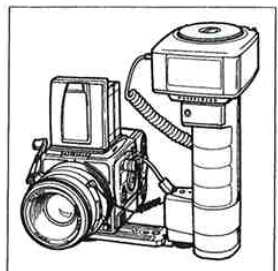

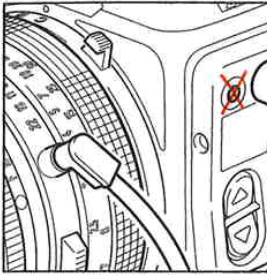

How to use the Dedicated Flash

(Camera shutter speed set at C)

Suggested procedure:

1. Attach the flash to the camera if desired.
2. Connect the TTL-cord according to the flash instruction.
3. Connect the PC-connector to the PC-socket on the CF-lens, **not** to the PC-socket in the camera body.
4. Set the flash unit in the desired mode of operation and switch it on. The green flash symbol in the viewfinder lights up when the flash is ready to fire.
5. Select shutter speed and pre-set aperture on the lens.
6. Press and release the exposure button to make an exposure, observing the viewfinder display for warning indications.
7. Rewind the camera to get the viewfinder image back, cock the shutter and advance the film to the next frame.



NOTE: When used at full power some electronic flash units have a flash duration longer than 1/500 s. To take advantage of the full flash power in such cases and to avoid "Lo FLASH" warning and under-exposure you are recommended to use shutter speeds of 1/125 s or slower.

Non-dedicated Flash Units

The non-dedicated flash unit should be connected to the PC-socket on the lens only. The exposure is controlled either by the flash itself or by aperture value settings calculated from the guide number of the flash (see the flash manual). There will be no indications or warnings in the viewfinder.

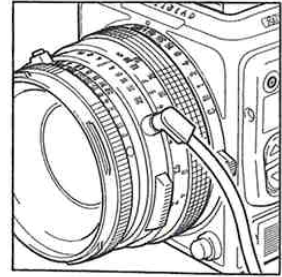

How to use the Non-dedicated Flash Unit.
(Camera shutter speed ring set at C).

Suggested procedure:

1. Attach the flash to the camera if desired.
2. Connect the synch cord to the PC-socket on the CF-lens, **not** to the PC-socket in the camera body.
3. Set the flash unit at the desired mode and switch it on.
4. Select and pre-set aperture and shutter speed (preferably 1/125 s or slower).
5. Press the exposure button to make an exposure.
6. Rewind the camera to get the viewfinder image back, cock the shutter and advance the film to the next frame.

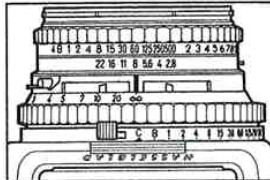
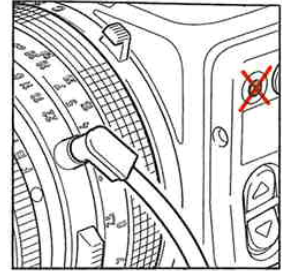

C-lenses

The older C-lenses (production terminated in 1982) look different but are in most respects identical to the CF-lenses. There are, however, four major differences:

1. There is no F-setting on the shutter.
2. The shutter speed and aperture rings are normally interlocked.
3. There are two different flash synchronization modes.
4. There is a built-in mechanical selftimer.

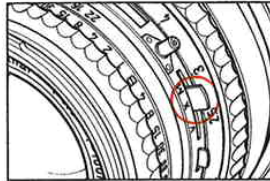

How to use the C-lens

Avoid using the focal plane shutter together with a C-lens. If it cannot be avoided follow the procedure below:

1. Set the lens shutter at **B**.
2. Pre-set the desired aperture.
3. Set the camera shutter at the desired shutter speed.
4. Press the exposure button to make an exposure.
5. Rewind the camera to get the viewfinder image back, cock the shutter and advance the film to the next frame.

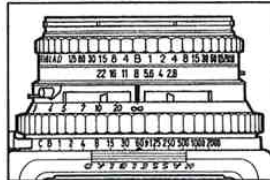

Lens in C mode

The procedure is identical with the CF-lens procedure (page 85).

Flash photography with the C-lens

Using the camera's focal plane shutter
With the lens shutter set at B the lens can be used as an F-lens.

Dedicated and Non-dedicated Flash Units
Follow the corresponding procedures for the F-lens (page 71).

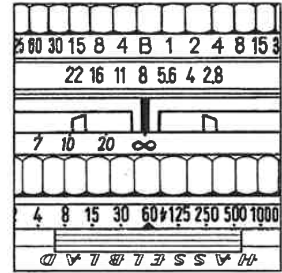

Using the C-lens' leaf shutter

Make sure that the flash mode selector is set at X.

Dedicated and Non-dedicated Flash Units
Follow the corresponding procedures for the CF-lens (page 87).

